

QUANTU SERIES

CATALOG

WORLD CLASS INSTRUMENTATION

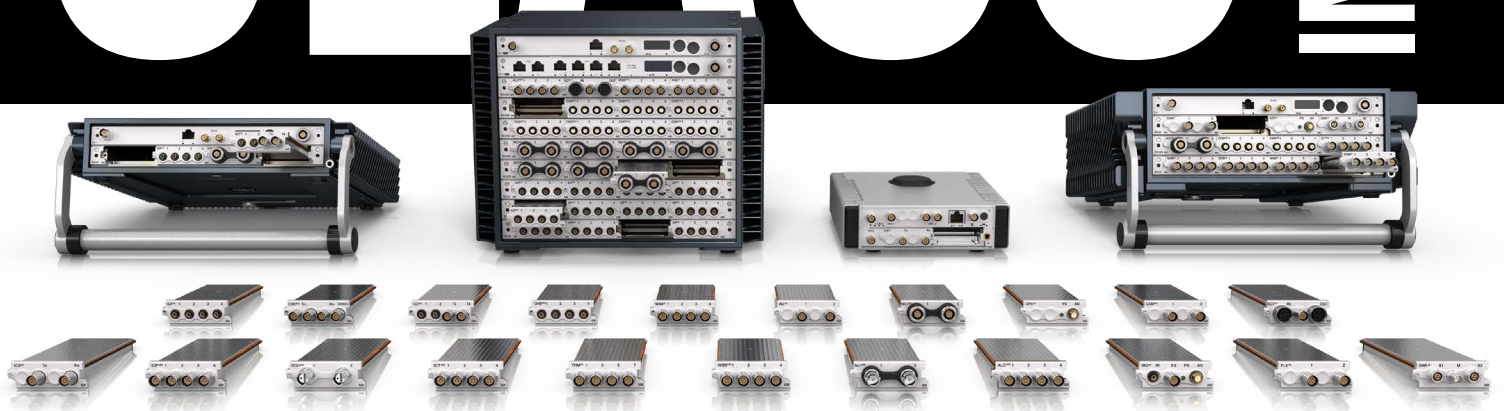



charged to innovate

For four decades, **MECALC** has been at the forefront of producing top-of-the-line data acquisition Systems renowned for their precision and signal conditioning quality.

While many companies in the data acquisition market offer both hardware and software, **MECALC** sets itself apart with its supreme focus on the engineering and production of exceptional instrumentation.

Our latest **QuantusSeries** product line is designed to be open and upgradeable across our existing platforms. Now with our growing software **PartnerNetwork**, **QuantusSeries**' embedded REST API, **QServer** enables various applications on the same System.

HELLO **QUANTUS**SERIES



DOWNLOAD
CATALOG
[MECALC.com](https://www.mecal.com)

QuantusSeries 08
QuantusSoftware 12

MICROQ black 26
General specifications
Accessories
Build your system
Examples

MICROQ 40
General specifications
Accessories
Modular signal conditional channels
Build your system
Examples

HELLO

26



42





58

DECAQ

- DECAQ and DECAQ Lean
- Upgrade
- Comparison
- Accessories
- Synchronization
- Build your system
- Examples

I/O Modules

Analog | Time, Position and Communication | Output | Monitoring

ICP® Voltage

ICP^{42S} | ICS⁴²

Microphone | ICP® Voltage

MIC^{42X}

Piezoelectric Charge | ICP® Voltage

CHS^{42X} | CHM^{42X} | DCH^{42S}

Tacho | ICP® Voltage

ICT^{42S}

Temperature | Voltage

THM⁴²

Strain | Bridge | ICP® voltage

WSB^{42X} | WSB⁴²

High Speed | Strain | Bridge | Voltage

ALI^{42B} | ALI²⁵

Voltage Output

ALO^{42S}

Time and Position

GPS^{42S}

Communication - Digital bus

CAN^{42S}

ICP® Voltage | Communication

ACM⁴²

ATTOQ

SGPS | SNAV | Minterminal

Custom solutions | Parts and Spares

Services and Support

78



106



110

114



COMPACT
MOBILE
RUGGED
QUALITY
WIFI
ETHERNET
PoE
MODULAR
TACHO
CAN FD
STRAIN
MICROPHONE
TEMPERATURE
ICP[®] VOLTAGE
GPS
20 I/O MODULES

QUANTUSSERIES
WORLD CLASS INSTRUMENTATION

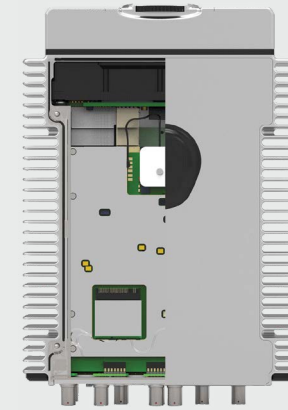

FUTURE PROOF

With more channels, faster sampling and innovative power management concepts our philosophy focuses on quality and compatibility across different sizes and configurations, from battery-powered for field measurements to large rack-mounted Systems in test cells. Combined with the wide range of interchangeable **QuantusSeries** I/O Modules, multiple Systems can be combined into a single System using PTP synchronization or GPS for remote Systems.

FOR EVERYONE

QUANTUSSERIES

QuantusSeries is more than just an acquisition platform. It is a complete front-end for the most demanding data acquisition applications in the industry.

In addition to a wide range of analog signal processing and sensor support, **QuantusSeries** uses state-of-the-art digital processing to improve phase accuracy, effective bandwidth, and scalability of the System for real-time measurements. From 2 to 1000s of channels, our Systems are the most portable, flexible, and scalable in the market.

With the launch of our embedded REST API interface, **QServer**, and included data acquisition software tools, we're opening up the playing field – instrumentation that comes standard for all your acquisition needs and that doesn't limit you to any specific software integration.

PORTABLE AND RACK-MOUNTABLE

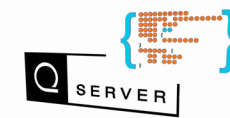

ULTRA PORTABLE



MODULAR SIGNAL CONDITIONING

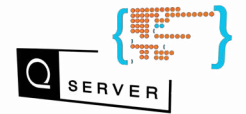
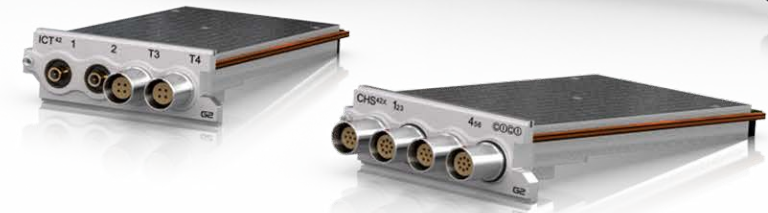

EASY
OPEN
REST API
MODERN
ACQUIRE
CHECK
MANAGE
ECOSYSTEM
INTERFACE
DATA
SIMPLE
VIEW
OPTIONS
GUIDED
CLICK
TRACK
MONITOR
INTERACT

INCLUDED
QUANTUS SOFTWARE
SUITE



BASIC ACQUISITION
DEVELOPER'S TOOLBOX
INTEGRATED SOLUTIONS

Our instrumentation comes with embedded software that we believe is necessary for you to be able to set up, control and record your measurement and a simple interface to write your own. For a full integrated solution choose a third-party software package from our **PartnerNetwork**.

#comes included

QuantusSoftware allows the users to develop their own applications, acquire data, and integrate third-party software packages for complete signal acquisition and analysis.

Working closely with our partners to innovate solutions that meet evolving needs in the market, our mission is to provide the latest advances in signal conditioning in a flexible product line that supports a wide range of applications. From robust portable Systems to large test cells, **MECALC** provides the most full-featured measurement Systems available.

With the launch of our embedded REST API interface, **QServer**, and included data acquisition software tools, we're opening up the playing field – instrumentation that comes standard for all your acquisition needs and that doesn't limit you to any specific software integration.

Where else can you be this confident in your data and measurement repeatability while having the flexibility to use your own software or that of any of our own software partners?

Ready when you are.

The **QAcquire** application will help setup and control the measurement, as well as collect and manage the data. Use the **QDataManager** Data Acquisition Utility to transfer and convert to different file formats.



Do it yourself.

Build on our out of the box acquisition using open-source toolboxes for data acquisition software development.

QServer is a REST API which allows a user application to set and validate configurations for measurement tasks. It's JSON format, makes it possible for users to develop applications in almost any programming environment.



Choose a solution.

Visit our website for a list of our partners who provide integrated solutions.



PARTNER NETWORK
MECALC.com/partners-distributors-network.php



Power Users.

Let's Collaborate

Our software partners work closely with us to guarantee personalized solutions for any individual software-hardware need. ScrumSpace serves as a platform where developers can find shared examples that facilitate the seamless integration of **QuantusSoftware** into their measurements.



#out of the box

This allows customers to use their **QuantusSeries** hardware immediately. The suite consists of the following:

- An embedded web application for configuring measurements and recording to the built-in SSD, Internal Data Storage.
- A Windows application which can download the Internal Data Storage data to the computer and convert it to standard data formats for analysis. Data formats include CSV, WAV, MATLAB and UFF.
- A Windows application that allows managing multiple **QuantusSeries** Systems.



OUT OF THE BOX

Ready when you are.

#developer

This also includes the tools software developers need to create their own applications.

HIGHLIGHTS INCLUDE:

- A REST API for easy measurement setup.
- Customizable data streaming formats allow developers to choose between high-performance applications and ease of use.
- Utility Libraries that can be integrated into applications to facilitate:
 - The discovery of devices on the network,
 - The upgrading the software running on the device,
 - The download and conversion of Internal Data Storage data to standard data formats
 - A plug-in-style customer data exporter interface to expand on the formats available for Internal Data Storage conversion.
 - Thin interface libraries for strongly typed languages (such as C#). These interface libraries help convert strongly typed values in the developer's application to their REST counterparts, reducing the integration time.



MATLAB
LABVIEW
PYTHON
C++
C#

DEVELOPERS

Do it yourself.

PartnerNetwork

Visit our website for more information

#partners



LANDTOP 朗德

SPECTRAL DYNAMICS

weles acoustics

SIGNALYSIS

COMPUTER METHODS

MULTIBOOT
PAK live.hub

MÜLLER-BBM
VibroAkustik Systeme

VIBES.technology

AKITRON
TAILORMADE TEST AND MEASUREMENT

VIBRANT

APEX Turbine®
Testing Technologies

HEAD acoustics

MATLAB
LABVIEW
PYTHON
C++
C#

MICROFLOWN
TECHNOLOGIES

QUANTUS SOFTWARE

CHOOSE

a Solution.

PARTNER NETWORK



What is Multiboot? *

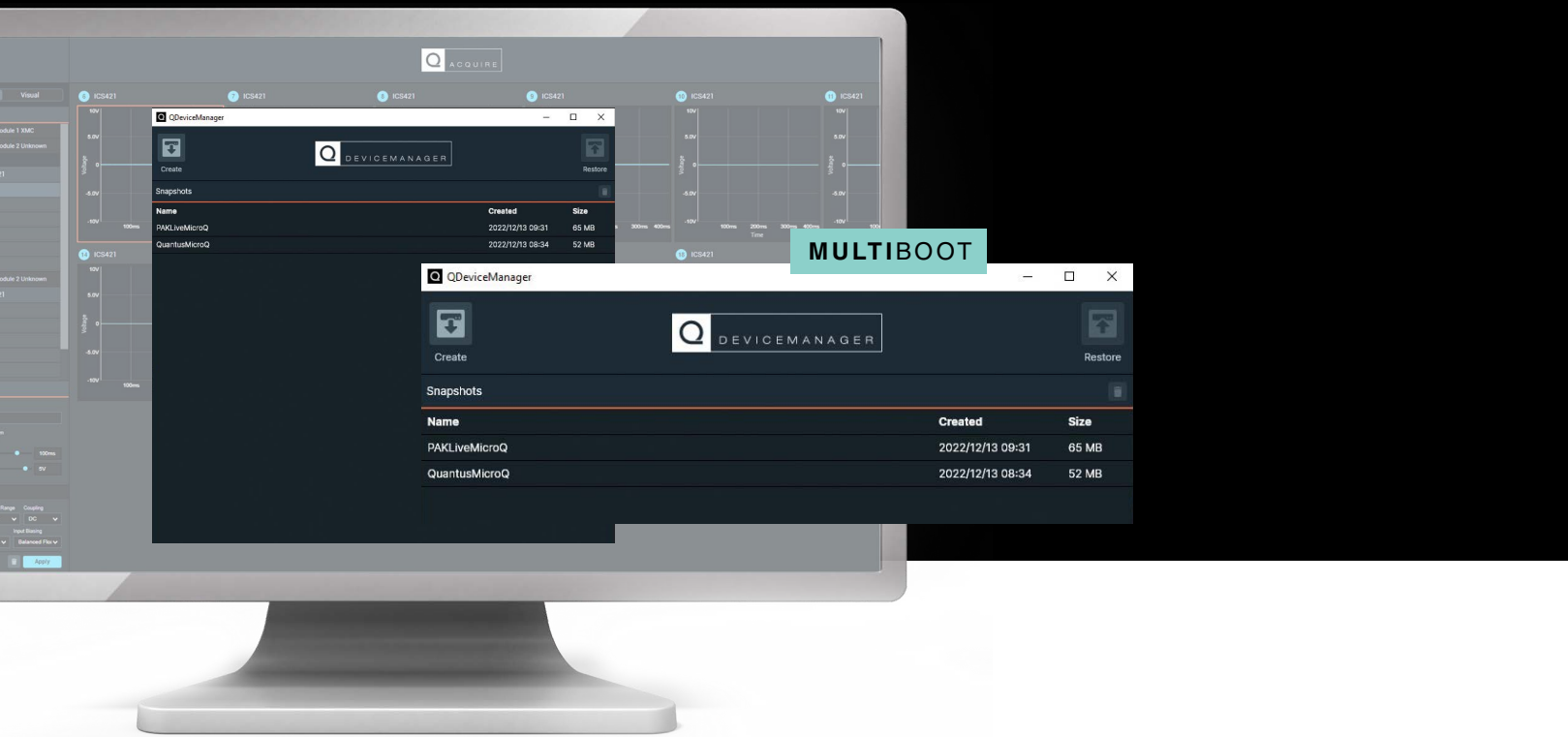

PAK live.hub and QServer are based on different versions of **QuantusSeries** firmware. Multiboot adds **QuantusSoftware** to a system and allows it to boot in multiple modes, configured for use with PAK live.hub or QServer compliant applications. In QServer mode, end users may also access the QServer API to develop their own applications. Multiboot is only needed for PAK live.hub users.

QDeviceManager is used to select the firmware boot mode. The process of reloading the system firmware to change between QServer or PAK boot modes requires approximately 20 minutes.

Multiboot is only available for **QuantusSeries DECAQ** and the latest Modules compatible with QServer.

Your Support

MECALC – Instrumentation (Calibration and extended warranty), **QuantusSoftware** and **Multiboot**

MÜLLER-BBM VAS SYSTEME – System when running PAK software

PARTNERNETWORK – System when running integrated software

MULTIBOOT
PAK live.hub
MÜLLER-BBM
VibroAkustik Systeme
VIBES.technology



MATLAB
LABVIEW
PYTHON
C++
C#



WITH MULTIBOOT, A **QUANTUSSERIES** SYSTEM CAN

BOOT TO SUPPORT MÜLLER-BBM PAK LIVE.HUB

OR QSERVER COMPATIBLE APPLICATIONS

QUANTUS SOFTWARE

#scrumspace

Being a Power User means you're not just using **QuantusSoftware** – you're shaping it, tweaking it, and making it your own. Build on our out-of-the-box acquisition using open-source toolboxes for data acquisition and analysis software development or choose multiple pre-integrated solutions from our **PartnerNetwork**.

Let's collaborate on **ScrumSpace**, a platform where Power Users can find shared examples that facilitate the seamless integration of **QuantusSoftware** into their measurements. Together, we can turn your ideas into reality and create software solutions customized to your measurement needs. On GitHub find our Developer's Toolbox where you can access open-source toolboxes for data acquisition software development, and contribute your own solutions and tips to the platform.

Whether you are working with **QuantusSoftware** out of the box basic acquisition, a developer doing it yourself with the help of our **QServer** REST API, or integrating with a **PartnerNetwork** solution becoming a Power User is for anyone who wants to integrate **QuantusSoftware** and take their measurements to the next level.

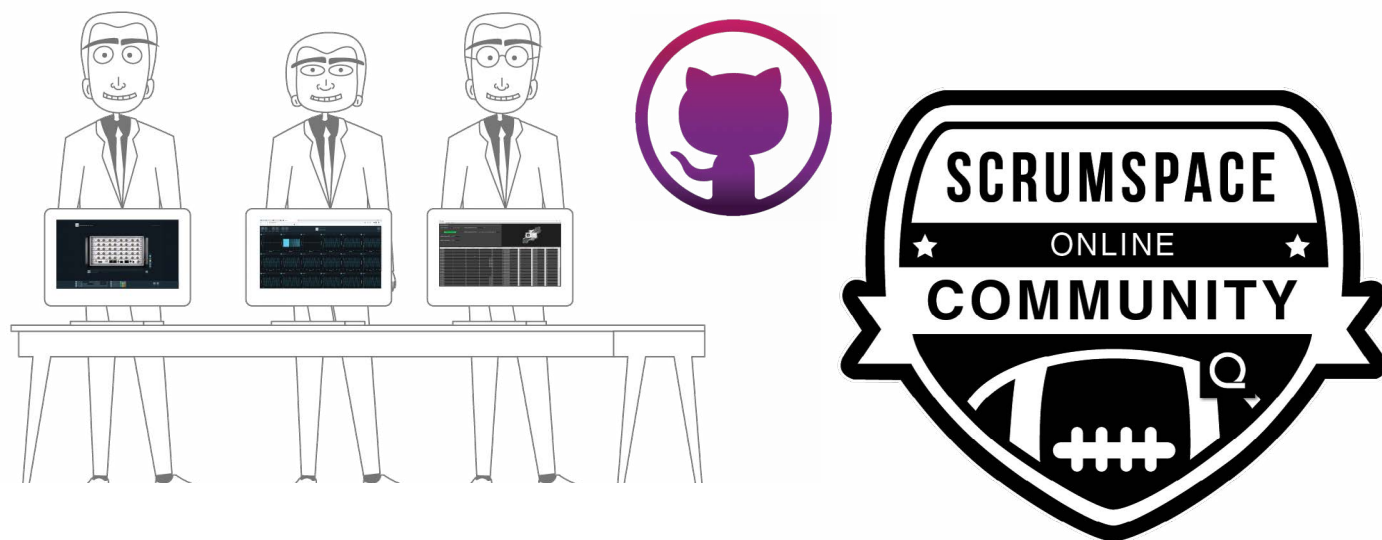

MATLAB
LABVIEW
PYTHON
C++
C#

POWER USERS

Let's collaborate.



GITHUB

<https://github.com/MECALC>



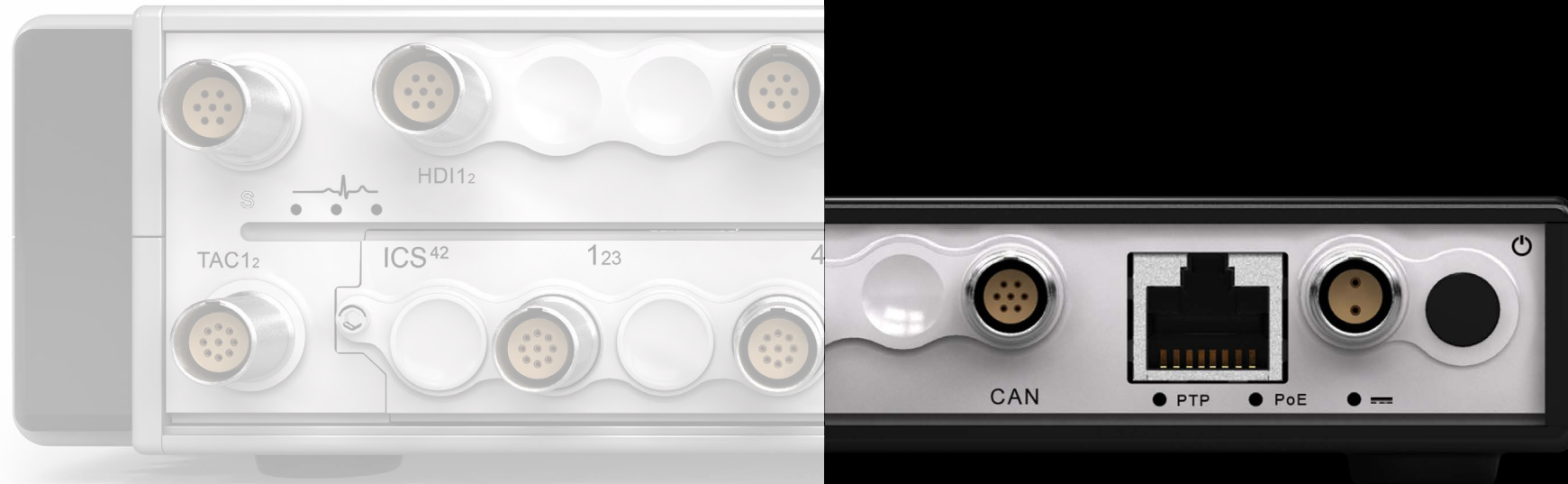

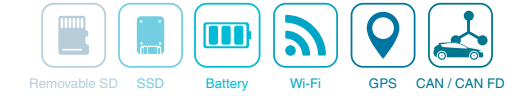

The MICROQ black provides accessible, no-fuss measurement without breaking the bank. Get laboratory quality measurements in a small package - just what you need, no more, no less.

#tethered

The MICROQ black tethered is a compact device for benchtop or embedded Systems. It is a basic measurement System that is connected to a PC and powered with DC Power or Power over Ethernet. Configurations come with built-in ICP® channels and a CAN / CAN FD interface.

#independent

The MICROQ black independent is a portable compact System for field use. In addition to standard DC and Power over Ethernet power options, all MICROQ black independent Systems come standard with internal data storage and an internal battery. Configurations come with built-in ICP® channels and a CAN / CAN FD interface. Options with Wi-Fi and GPS are available.



GENERAL SPECIFICATIONS



QUANTUS SOFTWARE:

QServer | QAcquire | QDataManager | Your own Software

BUILT-IN FEATURES:

CHANNELS

ICP® channels

24-bit Analog Input channels - ICP® up to 204.8 kSa/s per channel

Available with BNC, SMB or LEMO® connectors

CAN / CAN FD

Conforms to ISO 11898-1:2015 (“ISO CAN FD”)

Supports Arbitration Bit Rates from 50 kbit/s to 1000 kbit/s

Supports Data Bit Rates from 500 kbit/s to 8000 kbit/s (single channel only), or 2000 kbit/s (both channels simultaneously)

Wi-Fi (Available on selected MICROQ black Independent)

Encrypted Wi-Fi Network | IEEE 802.11b, g and n

GPS (Available on selected MICROQ black Independent)

Internal GPS for time synchronization and position

Receiver type: 56 channels GPS L1C/A, QZSS L1C/A (GALILEO and GLONASS optional)

Position accuracy: 2.5 m

Position and time update rate of up to 4 Hz

POWER:

POWER OVER ETHERNET

Ethernet

IEEE 802.3at Type 2, LTPoE++ | 1000BASE-T

Power

Input voltage range 42-57 VDC

Power source required: up to 40 W

PTP (Precision Time Protocol)

Synchronization over PTP IEEE (1588-2008) with other MICROQs, DECAQs and other PTP compatible devices.

DC POWER

For automotive power or a standard power adapter | 10-30 VDC

BUILT-IN INTERNAL BATTERY (Available on all MICROQ black Independent)

Li-Ion Battery | Up to 2 hours operation time

S-PORT:

The S-Port supports optional additional external Modules to increase signal conditioning and measurement placement possibilities. (coming soon)

CALIBRATION:

ISO / IEC 17025 Factory Calibrated

ENVIRONMENTAL SPECIFICATIONS

Machined from aluminum for field use

Conduction / convection cooled

Closed Systems with no internal airflow

Humidity <small>non-condensing</small>	5 % - 90 % RH	
Shock ¹ <small>11 ms duration</small>	55 g vertical 40 g Transverse and Longitudinal	
Random Vibration ² <small>from 10 to 2000 Hz</small>	0.1 g ² /Hz Vertical 0.05 g ² /Hz Transverse and Longitudinal	
Max Power Input	25 W	
Typical Power Consumption	10 - 15 W	
Maximum Internal Frequency	2.5 GHz	
Ground Connector Type	4 mm Connector	
Typical Mounting	Tabletop Din Rail	
Ambient Operating Temperature	MICROQ black tethered: -40 °C (-40 °F) to 55 °C (131 °F)	MICROQ black independent: -20 °C (4 °F) to 50 °C (122 °F)

PHYSICAL:

Dimensions (W H D)	MICROQ black tethered: 142 x 32 x 180 mm (5.59 x 1.25 x 7")	MICROQ black independent: 172 x 36 x 241 mm (6.77 x 1.41 x 9.48")
Mass	MICROQ black tethered: 1.5 kg (3.31 lbs)	MICROQ black independent: 2 kg (4.41 lbs)

¹ MIL-STD-810G Method 516.6 Procedure V: Shock
² MIL-STD-810G Method 514.6 Procedure I: Vibration

Bumper.

FOR ADDITIONAL PROTECTION

Ever the adventurer, the MICROQ black's portability may lead it to be used in extreme environments. For protection against exposure to unconventional measurement conditions, the MICROQ black bumper provides additional shielding to an already rugged design.



Sleeve.

FOR ADDITIONAL PROTECTION

MICROQ black leather sleeve (tethered / independent). The leather sleeve can be ordered as a spare to protect your MICROQ black from bumps and scratches





Mount Bracket.

MICROQ BLACK MOUNT BRACKET





Keep your MICROQ black secure with a custom-designed bracket that allows the MICROQ black to mount to a 1-inch DIN rail or ¼-20 Tripod Mount. The fastening clip makes it possible to mount the MICROQ black in different positions







SIGNAL CABLES

ITEM NUMBER	DESCRIPTION	
CC-CAN10-D	<ul style="list-style-type: none"> - CANbus Cable. 7-pin LEMO® connector to 9-pin D-sub connector. - Length: 300 mm and 2 m (2000) 	
CS-MQB-ICP-J	<ul style="list-style-type: none"> - ICP®/ Voltage Sensor Cable. 4-pin LEMO® to BNC Jack connector. - Supports ICP®/ Voltage Inputs on MICROQ black. - Length: 1 m 	
CS-MQB-ICP-SP	<ul style="list-style-type: none"> - ICP®/ Voltage Sensor Cable. 4-pin LEMO® to Sensor Power Connector. - Supports ICP®/ Voltage Inputs with Sensor Power on MICROQ black. - Length: 1 m 	

POWER OPTIONS

ITEM NUMBER	DESCRIPTION	
PA-MQ	<ul style="list-style-type: none"> - Standard Power Adapter for MICROQ, MICROQ black, SP10 or SP45 - Mains Power Adapter, 2-pin LEMO® connector - Note: Specify Mains Power Connector type when ordering 	
PA-MQ-POE	<ul style="list-style-type: none"> - Spare PoE Power Injector MICROQ, MICROQ black - 50 W 	
CP-MQ-CL	<ul style="list-style-type: none"> - Automotive Power Cable for MICROQ and MICROQ black - 2-pin LEMO® (MICROQ) to Cigarette Lighter - Length: 2 m 	
CP-MQ-MW	<ul style="list-style-type: none"> - Power Cable for the MICROQ and MICROQ black - 2-pin LEMO® connector to Mean Well GST 160A15-R7B power supply - Length: 2m 	

ACCESSORIES

ITEM NUMBER	DESCRIPTION	
MQ-SD-32	<ul style="list-style-type: none"> - Removable 32 GB SD for MICROQ black independent (Spare) 	
MQB-BPR-T	<ul style="list-style-type: none"> - MICROQ black tethered bumper. Protect your MICROQ black from additional shock and strain during field use with the MICROQ black bumper. 	
MQB-SLV-T MQB-SLV-I	<ul style="list-style-type: none"> - MICROQ black leather sleeve (tethered / independent). The leather sleeve can be ordered as a spare to protect your MICROQ black from bumps and scratches 	
MQB-BKT-T	<ul style="list-style-type: none"> - Anodised aluminum Mounting Bracket, mounts a MICROQ black to a 1-inch DIN Rail or ¼-20 Tripod Mount. - The spring clip can be positioned in 4 locations on the bracket, allowing different mounting options 	

BUILD YOUR SYSTEM

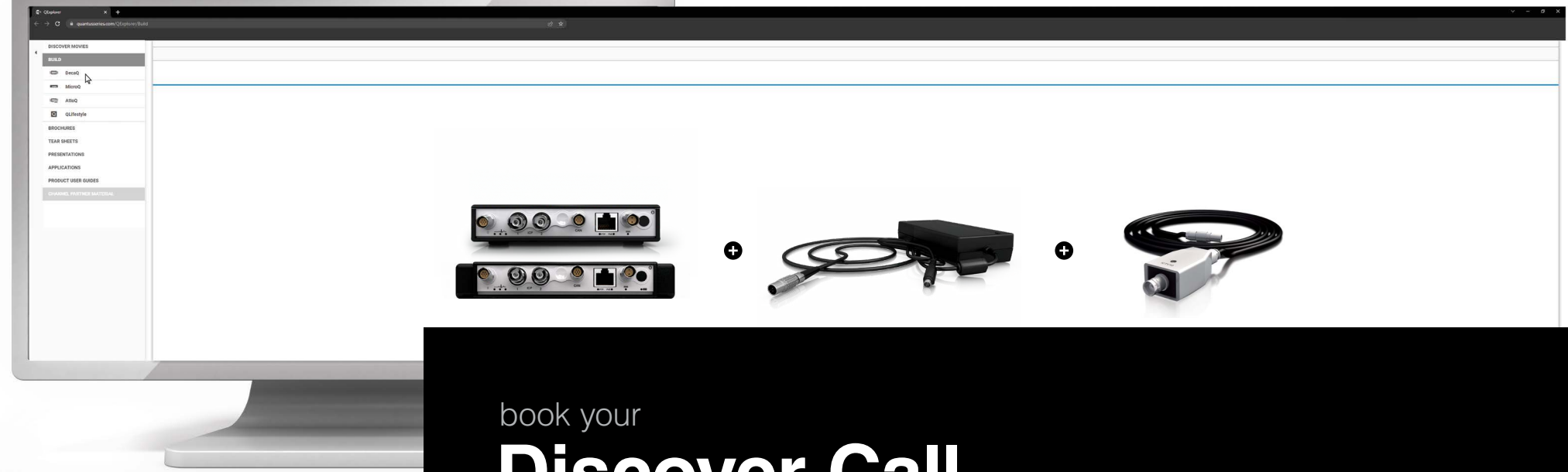

book your
Discover Call
today.

CHOOSE

1. CONFIGURATION

Choose the configuration that best suits your measurement requirements by deciding on the following features:

TETHERED OR INDEPENDENT

- Tethered: for test stands and laboratory use, connected to a PC
- Independent: internal data storage and internal battery for field use

BUILT-IN CHANNELS

- ICP® and CAN / CAN FD

Wi-Fi AND GPS (MICROQ black independent configurations only)

2. POWER CABLES

All MICROQ black Systems ship with a PoE (Power over Ethernet) Adapter. Additional power cables are available as optional extras, including a standard Power Adapter and an Automotive Power Cable.

3. SIGNAL CABLES AND SUBMODULES

Add Signal Cables and SubModules related to the built-in I/O channels and interfaces found on your MICROQ black.

ADD

4. SYNCHRONIZE

Add a PTP switch to synchronize multiple MICROQ black Systems. QS-Sync enables the synchronization of multiple QuantusSeries Systems using PTP (Precision Time Protocol).

PTP Synchronization must be purchased for each System in a synchronized group. The package includes up to 6 hours of technical support.

5. ACCESSORIES

Add a MICROQ black Mounting Bracket for easy mounting or a MICROQ black Bumper for additional protection. MICROQ black comes with a leather sleeve which can also be purchased separately if a replacement is needed.

6. CALIBRATION AND WARRANTY SERVICES

Calibration services improve the System's performance and ensure it works optimally for longer. Add these services and adjust the warranty period as needed.

CUSTOM CABLES

EXAMPLES

Below are application examples showing how the MICROQ black supports each measurement's requirements. Tell us about your application, and together we'll choose the right MICROQ black configuration for your measurement solution.

EMBEDDED SYSTEM

PRODUCTION END-OF-LINE TEST

Periodic data collection on ICP® Input Channels for accelerometer and microphone based measurements, using Ethernet to communicate with the central test management System.

CHOOSE

MICROQ BLACK † C-2BNC

- 2x ICP® input Channels
- 1x CAN / CAN FD Channels

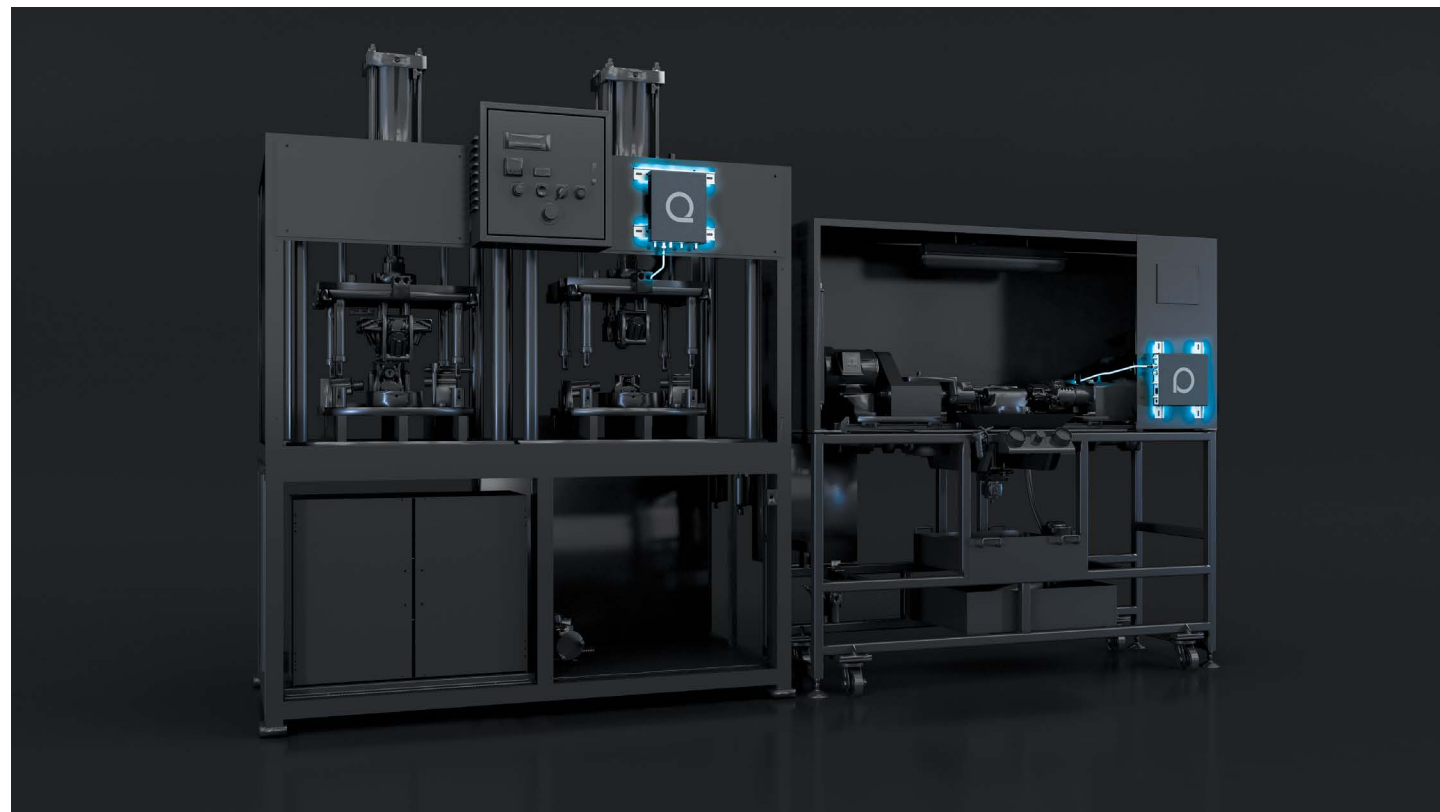

DISTRIBUTED DATA ACQUISITION

BRIDGE VIBRATION MEASUREMENT

Record 4 triaxial accelerometers 20 m apart. Distributed locations, synchronized data sampling (one triaxial accelerometer at each location).

CHOOSE

MICROQ BLACK †+ OBC-4SMB

- Internal Battery
- 2x ICP® Input Channels per System
- 1x CAN / CAN FD Channels
- PTP IEEE 1588-2008 (Precision Time Protocol)

OR

CHOOSE

MICROQ BLACK † C-4SMB

- Systems powered from a central power source via PoE Power Injectors
- 2x ICP® Input Channels per System
- 1x CAN / CAN FD Channels
- PTP IEEE 1588-2008 (Precision Time Protocol)

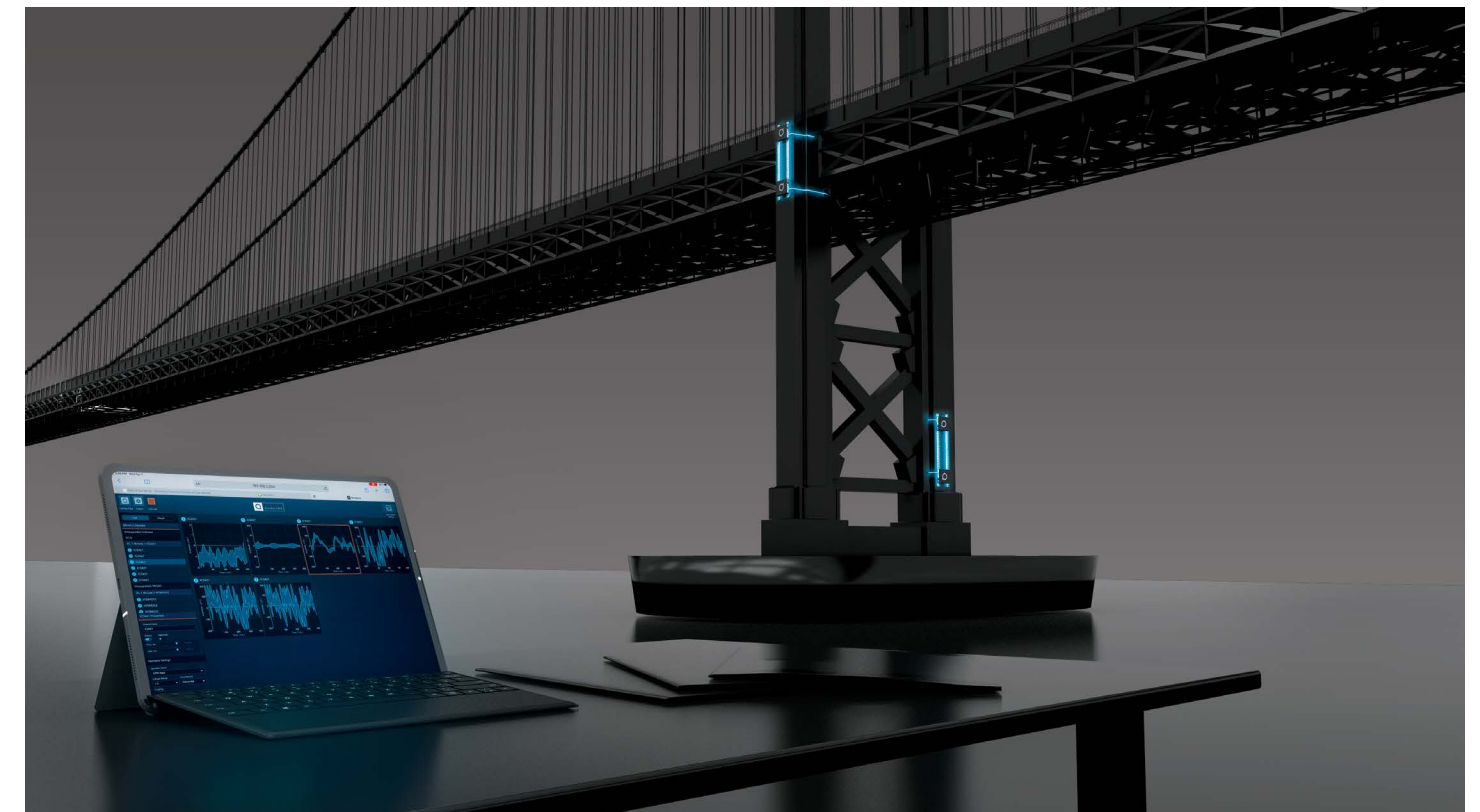





The MICROQ provides a flexible platform for a wide variety of interchangeable **QuantusSeries** I/O Modules, as well as synchronization with other Systems. A set range of configurations is available, each one able to support almost any testing scenario.

Compact and portable, the MICROQ tethered and MICROQ independent are hand-held Systems that can be synchronized to increase channel count and facilitate distributed measurements.

QuantusSeries Modules can be added / removed and saved for unique application requirements. Multiple MICROQ Systems can be combined to form a larger System. These Systems are synchronized using a PTP Switch.

#tethered

The MICROQ tethered is a compact device for benchtop or embedded Systems. It is a basic measurement System that is connected to a PC and powered with DC Power or Power over Ethernet. Configurations are available with built-in channels for Tacho, CAN / CAN FD and HDI. Add up to two **QuantusSeries** I/O Modules for more channels.

#independent

The MICROQ independent is a portable compact System for field use. In addition to standard DC and Power over Ethernet power options, all MICROQ independent Systems come standard with internal data storage and an internal battery. Configurations are available with built-in channels for Tacho, CAN / CAN FD and HDI. Add up to two **QuantusSeries** I/O Modules for more channels.

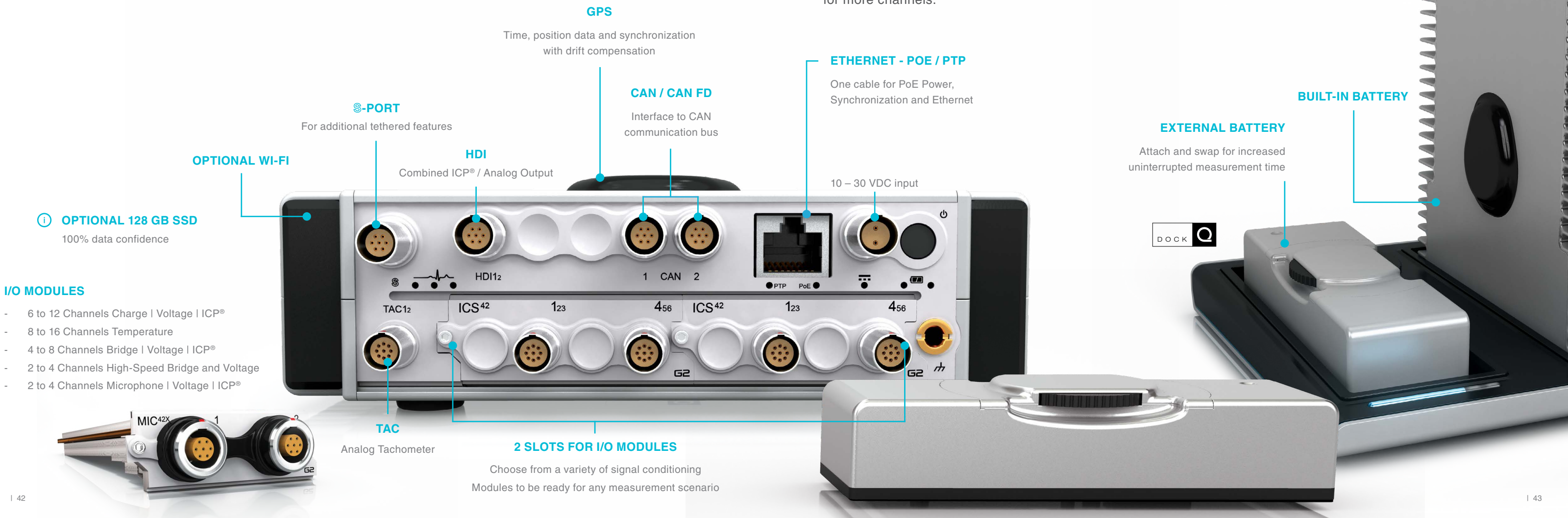

OPTIONAL 128 GB SSD
100% data confidence

- I/O MODULES**
- 6 to 12 Channels Charge | Voltage | ICP®
 - 8 to 16 Channels Temperature
 - 4 to 8 Channels Bridge | Voltage | ICP®
 - 2 to 4 Channels High-Speed Bridge and Voltage
 - 2 to 4 Channels Microphone | Voltage | ICP®



#tethered

MICROQ t

2 slots for interchangeable I/O Modules
**Modules not included in basic configurations*



MICROQ t

MICROQ t+ T

2 slots for interchangeable I/O Modules
**Modules not included in basic configurations*
 2 Tachometer channels



MICROQ t+ T

MICROQ t+ CT

2 slots for interchangeable I/O Modules
**Modules not included in basic configurations*
 2 Tachometer channels
 2 CAN / CAN FD channels



MICROQ t+ CT



Modules sold separately. See **QuantusSeries I/O Modules section for more information.*

#independent

MICROQ / 1B

2 slots for interchangeable I/O Modules
**Modules not included in basic configurations*
 Internal Data Storage
 Internal Battery



MICROQ / 1B

MICROQ i+ 1BCHT

2 slots for interchangeable I/O Modules
**Modules not included in basic configurations*
 Internal Data Storage
 Internal Battery
 2 Tachometer channels
 2 CAN / CAN FD channels
HDI: High Definition Interface



MICROQ i+ 1BCHT

MICROQ i+ W1BCGT

2 slots for interchangeable I/O Modules
**Modules not included in basic configurations*
 Internal Data Storage
 Internal Battery
 Wi-Fi
 2 Tachometer channels
 2 CAN / CAN FD channels
 Internal GPS receiver



MICROQ i+ W1BCGT

MICROQ i+ W1BCGHT

2 slots for interchangeable I/O Modules
**Modules not included in basic configurations*
 Internal Data Storage
 Internal Battery
 Wi-Fi
 2 Tachometer channels
 2 CAN / CAN FD channels
HDI: High Definition Interface
 Internal GPS receiver



MICROQ i+ W1BCGHT

GENERAL SPECIFICATIONS



QUANTUSSOFTWARE:

QServer API | QAcquire Application Software

BUILT-IN FEATURES:

CHANNELS (Available in various set configurations)

TACHO

2 x Tachometer channels | 20 ns resolution | 700 kPulse/s rate for the sum of the two channels

HDI

2 x 24-bit Analog Input channels, ICP® up to 204.8 kSa/s per channel (± 7 V voltage limitation)

2 x Audio Output channels for a binaural headset

CAN / CAN FD

Conforms to ISO 11898-1:2015 ("ISO CAN FD")

Supports Arbitration Bit Rates from 50 kbit/s to 1000 kbit/s

Supports Data Bit Rates from 500 kbit/s to 8000 kbit/s (single channel only), or 2000 kbit/s (both channels simultaneously)

Wi-Fi (Available on selected MICROQ independent Systems)

Encrypted Wi-Fi Network | IEEE 802.11b, g and n

GPS (Available on selected MI-CROQ independent Systems)

Internal GPS for time synchronization and position

Receiver type: 56 channels GPS L1C/A, QZSS L1C/A (GALILEO and GLONASS optional)

Position accuracy: 2.5 m

Position and time update rate of up to 4 Hz

INTERNAL DATA STORAGE

128 GB SSD

MODULAR SIGNAL CONDITIONING:

2 Slots for **QuantusSeries** I/O Modules. See **QuantusSeries** I/O Modules section for more information.

Modules ordered separately. Speak to your supplier about which Modules will best suit your measurement requirements.

POWER:

POWER OVER ETHERNET

Ethernet	IEEE 802.3at Type 2, LTPoE++ 1000BASE-T
Power	Input voltage range 42-57 VDC Power source required: up to 40 W
PTP (Precision Time Protocol)	Synchronization over PTP IEEE (1588-2008) with other MICROQs, DECAQs and other PTP compatible devices.

DC POWER

10-30 VDC | For automotive power or a standard power adapter.

MICROQ INDEPENDENT POWER OPTIONS:

INTERNAL BATTERY

Li-Ion Battery | 1.5 - 2 hours of operation time, depending on System configuration

EXTERNAL BATTERY

Adding an External Battery (MQ-BAT-EX) doubles battery life. Together with a DOCKQ docking station, the External Battery can be hot swapped for extended operation time.

DOCKQ

The DOCKQ docking station (DS10) charges both internal and external batteries, assisting in the hot-swapping of MICROQ batteries for extended untethered operation time. It takes about 2 hours to charge a MICROQ battery on the DOCKQ from fully depleted to fully charged.

It is recommended that the MICROQ be switched off while being charged on the DOCKQ.

S-PORT:

The S-Port supports optional additional external Modules to increase signal conditioning and measurement placement possibilities. (coming soon)

CALIBRATION:

ISO / IEC 17025 Factory Calibrated

ENVIRONMENTAL SPECIFICATIONS

Machined from aluminum for field use

Conduction/convection cooled

Closed Systems with no internal airflow

Ambient temperature	Min: -20 °C -4 °F, Max: 50 °C 122 °F
Humidity <small>non-condensing</small>	5 % - 90 % RH
Shock ¹ <small>11 ms duration</small>	55 g vertical 40 g Transverse and Longitudinal
Random Vibration ² <small>from 10 to 2000 Hz</small>	0.1 g ² /Hz Vertical 0.05 g ² /Hz Transverse and Longitudinal
Maximum Internal Frequency	1.25 GHz
Ground Connector Type	4 mm Connector

¹ MICROQ Shock standard: According to MIL-STD-810G Method 516.6, Procedure V. 1 g = 516.6 m/s²

² According to MIL-STD-810G Method 514.6, Procedure I. 1 g = 514.6 m/s²

PHYSICAL:

Dimensions (W H D)	6.77 x 2 x 9.88 " 172 x 53 x 251 mm
Volume	2.3 L / 0.59 gal
Mass, fully populated with Battery	2.25 kg 4.96 lb
Mass, fully populated without Battery	1.85 kg 4.08 lb
Mass with External Battery	2.70 kg 5.95 lb

ACCESSORIES

Share and charge.

All day convenience | 100% data confidence.

DOCKQ: MAINTENANCE STATION

Dock your MICROQ and your MICROQ External Battery onto the DOCKQ to charge and share data, giving you complete control of your power and data management.

Useful when charging MICROQ External Battery while measuring with your MICROQ, the DOCKQ ensures increased uninterrupted mobile measurement.

It only takes about 2 hours to charge a MICROQ External Battery on the DOCKQ from fully depleted to fully charged.

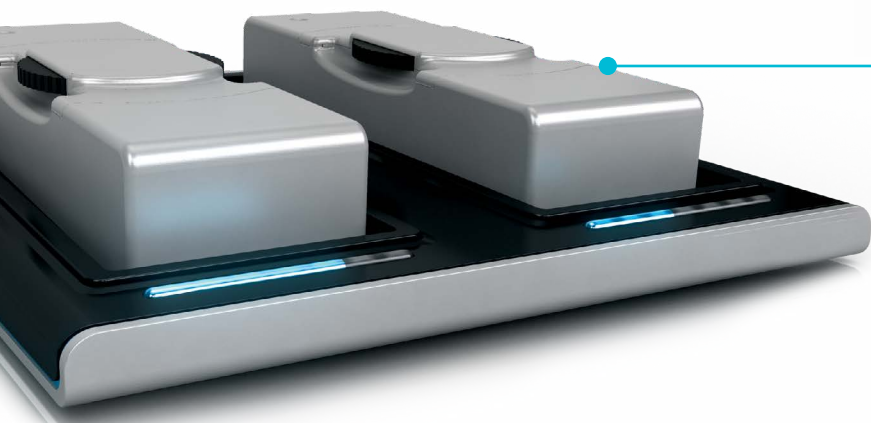

CHARGE

Dock onto the DOCKQ to charge - check blue LEDs for power levels.

EXTERNAL MICROQ BATTERY

For extended uninterrupted battery power simply attach a MICROQ External Battery to your MICROQ, without stopping your measurement.

Each Li-Ion battery adds a capacity of 40 Wh, increasing uninterrupted measurement time.



ATTACH OR REMOVE EXTERNAL MICROQ BATTERY

Turn the Battery Wheel to attach the External MICROQ Battery to your MICROQ.





Transport.

MICROQ CASE



For the jet-setter. The MICROQ case protects the chassis while in transit.



POWER OPTIONS FOR MICROQ^t AND MICROQⁱ

ITEM NUMBER	DESCRIPTION	
PA-MQ	<ul style="list-style-type: none"> - Standard Power Adapter for MICROQ, MICROQ black, SP10 or SP45 - Mains Power Adapter, 2-pin LEMO® connector - Note: Specify Mains Power Connector type when ordering 	
PA-MQ-POE	<ul style="list-style-type: none"> - Spare PoE Power Injector MICROQ, MICROQ black - 50 W - Note: Specify Mains Power Connector type when ordering 	
CP-MQ-CL	<ul style="list-style-type: none"> - Automotive Power Cable for MICROQ and MICROQ black - 2-pin LEMO® on the MICROQ to a Cigarette Lighter - Length: 2m 	
CP-MQ-MW	<ul style="list-style-type: none"> - Spare Power Cable for the MICROQ - 2-pin LEMO® connector to Mean Well GST 160A15-R7B power supply - Length: 2m 	







POWER OPTIONS FOR MICROQⁱ

ITEM NUMBER	DESCRIPTION	
MQ-BAT-EX	<ul style="list-style-type: none"> - MICROQ External Battery - Hot swappable - Adds battery power to the MICROQ independent - Each battery adds 40 Wh capacity 1.5-2 hours of active use - Recharge External Battery on the DOCKQ or a powered MICROQ 	
DS10	<ul style="list-style-type: none"> - DOCKQ - Docking Station for the MICROQ independent - Charge MICROQ independent, download data to a PC - Includes 120 W Power Adapter 	



SYNCHRONIZATION OPTIONS

ITEM NUMBER	DESCRIPTION
QS-SYNC-PTP-S	<ul style="list-style-type: none"> - Enable PTP Synchronization Slave - One license needed per System
QS-SYNC-GPS	<ul style="list-style-type: none"> - Enable GPS Synchronization - One license needed per System

SENSOR CABLES AND SUBMODULES FOR MICROQ

ITEM NUMBER	DESCRIPTION	
CC-CAN10-D	<ul style="list-style-type: none"> - CANbus Cable. 7-pin LEMO® connector to 9-pin D-sub connector. - Length: 300 mm (300) and 2 m (2000) 	
CS-TAC-MQ-2J	<ul style="list-style-type: none"> - Tachometer Interface Cable. 9-pin LEMO® connector on the MICROQ to 2 BNC Jack Connectors. - Supports MICROQ Tachometer inputs. - Length: 600 mm 	
CS-TAC-MQ-2L	<ul style="list-style-type: none"> - Tachometer Interface Cable. 9-pin LEMO® connector on the MICROQ to two 4-pin LEMO® connectors with the same pinout as the MD-ICT42 and MD-ICT42S for tachometer sensors. Interfaces the Tachometer interface on the MICROQ to SM-ICTV11 and CS-TAC used with MD-ICTV42S. - Length: 600 mm 	
CS-TAC-J	<ul style="list-style-type: none"> - Tachometer sensor cable. 4-pin LEMO® connector to BNC Jack connector. - Supports Tacho input channels on MICROQ via the CS-TAC-MQ-2L cable. - Length: 1 m 	
SM-ICTV11	<ul style="list-style-type: none"> - Tachometer Over-Voltage SubModule. Protects Tachometer inputs from high voltage spikes. - Supports MICROQ tachometer inputs via the CS-TAC-MQ cable. 4-pin LEMO® to BNC Jack connector. Compatible with RM-SM10 1U RackMount. - Length: 300 mm 	
CS-HDI	<ul style="list-style-type: none"> - HDI Interface Cable. 7-pin LEMO® connector on the MICROQ independent (HDI Interface) to 2 BNC connectors and a 3.5 mm Audio Jack for a stereo headset. - <i>Audio Jack coming soon</i> - Length: 2 m 	

MICROQ ACCESSORIES

ITEM NUMBER	DESCRIPTION	
TC-MQ	<ul style="list-style-type: none"> - Air Case with Dual Layer Foam Insert for MICROQ and accessories - Meets travel guidelines for carry-on luggage - Exterior Dimensions (L x W x D): 21.96 x 11.97 x 8.98 ", 55.8 x 30.4 x 22.8 cm - Case weight 10 lbs. 	
MQ-SLV	<ul style="list-style-type: none"> - Spare MICROQ leather sleeve. - The leather sleeve can be ordered as a spare to protect your MICROQ from bumps and scratches. 	

CUSTOM CABLES

MECALC will design and manufacture custom cables on request.

MODULAR SIGNAL CONDITIONING CHANNELS

MODULAR I/O SIGNAL CONDITIONING CHANNELS *(see module section)*

The MICROQ tethered and independent have two open Module slots for QuantusSeries I/O Modules. See the QuantusSeries I/O Modules section for more information.



MODULE COVER - MBL

Module Covers need to be purchased for any empty Module slots on the MICROQ. These covers protect the System from any environmental damage that might take place when the Module slots are not in use.

ITEM NUMBER	DESCRIPTION
-------------	-------------

- | | |
|-----|--------------------------------|
| MBL | - Module Blank. |
| | - Covers empty I/O Module slot |



The same I/O Modules over our vast variety of Systems. Keep it modular over DECAQ and MICROQ

see
I/O MODULES 
for more detail

BUILD YOUR SYSTEM

The **QuantusSeries MICROQ** is offered with a variety of internal options. Select the MICROQ configuration desired and add options for Accessories, I/O Modules, and ATTOQs to complete the System.

Internal options of the MICROQ are only available in fixed configurations and cannot be updated or modified. All MICROQs ship with a PoE (Power over Ethernet) Adapter. A Standard Power Adapter is available if required, to be ordered separately.

QuantusSeries Modules can be added or swapped for a wide variety of applications. Multiple MICROQ Systems can be combined to form a larger System. These Systems are synchronized using a PTP Switch.

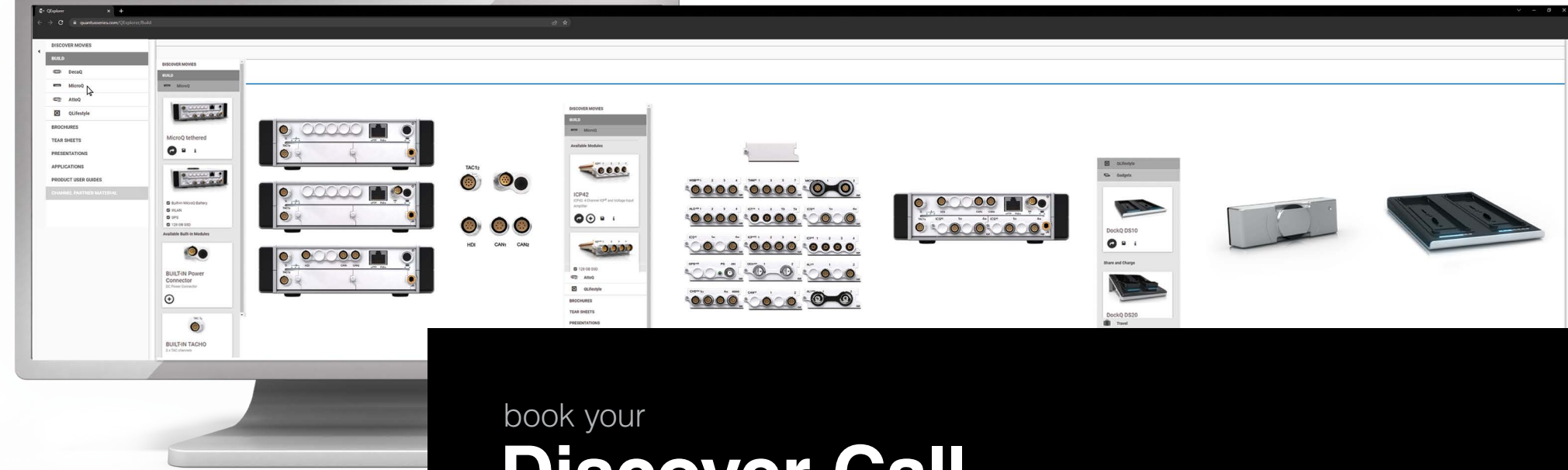

book your
Discover Call
today.



CHOOSE

1. CONFIGURATION

Choose the configuration that best suits your measurement requirements by deciding on the following features:

TETHERED OR INDEPENDENT

- Tethered: for test stands and laboratory use, connected to a PC
- Independent: internal data storage and internal battery for field use

BUILT-IN CHANNELS

- Tacho | CAN / CAN FD | High Definition Interface

Wi-Fi (MICROQ independent option)

GPS (MICROQ independent option)

2. POWER OPTIONS

All MICROQ Systems ship with a PoE (Power over Ethernet) Adapter. Additional power cables are available as optional extras, including a standard Power Adapter and an Automotive Power Cable.

MICROQ independent Systems support External Batteries (hot swappable) for extended operation. Add DOCKQ Docking Station for charging batteries and the MICROQ. DOCKQ also supports Ethernet connectivity for data download.

3. SIGNAL CABLES AND SUBMODULES

Add Signal Cables and SubModules related to the built-in I/O channels and interfaces found on your MICROQ.

ADD

4. I/O MODULES, RELATED SIGNAL CABLES AND SUBMODULES, MODULE COVER

Add I/O Modules as needed to increase channel count. 2 Module slots are available on all MICROQ configurations, I/O Modules may be swapped in the field as needed.

Add Signal Cables and SubModules for the chosen I/O Modules. Add Module Covers to protect empty Module slots.

SYNCHRONIZE

5. Add a PTP switch to synchronize multiple MICROQ Systems.
Add License for PTP (Precision Time Protocol) QS-SYNC-PTP-S. PTP Synchronization must be purchased for each System in a synchronized group. The package includes up to 6 hours of technical support.

ACCESSORIES

6. Add a travel case to complete your measurement setup. The MICROQ comes with a leather sleeve which can also be purchased separately if an additional sleeve is required at any point.

CALIBRATION AND WARRANTY SERVICES

7. Calibration services improve the System's performance and ensure it works optimally for longer. Add these services and adjust the warranty period as needed.

CUSTOM CABLES

MECALC will design and manufacture custom cables on request.

EXAMPLES

Below is an application example showing how a certain configuration of the MICROQ supports a specific measurement's requirements. Tell us about your application, and together we'll choose the right MICROQ configuration for your measurement solution.

PORTABLE FIELD TEST

AUTOMOTIVE

Record location, vehicle status via CAN / CAN FD, vibration data and rotation speed in a moving vehicle.

CHOOSE

MICROQ/+ 1BCHT

2x ICP® Input Channels

2x Tachometer Channels

2x CAN / CAN FD Channels

Internal Battery (External Battery optional)

ADD QUANTUSERIES I/O MODULES

MD-ICS42 x2 ICP®/Voltage Input Module
12x ICP® Input Channels

ADD CABLES

CS-HDI x1 HDI Interface Cable

CS-ICS-3J x4 Three-BNC Signal Cable

CS-TAC-MQ-2J x1 Tachometer Interface Cable

CC-CAN10-D x2 CANbus Cable

CP-MQ-CL x1 Automotive Power Cable

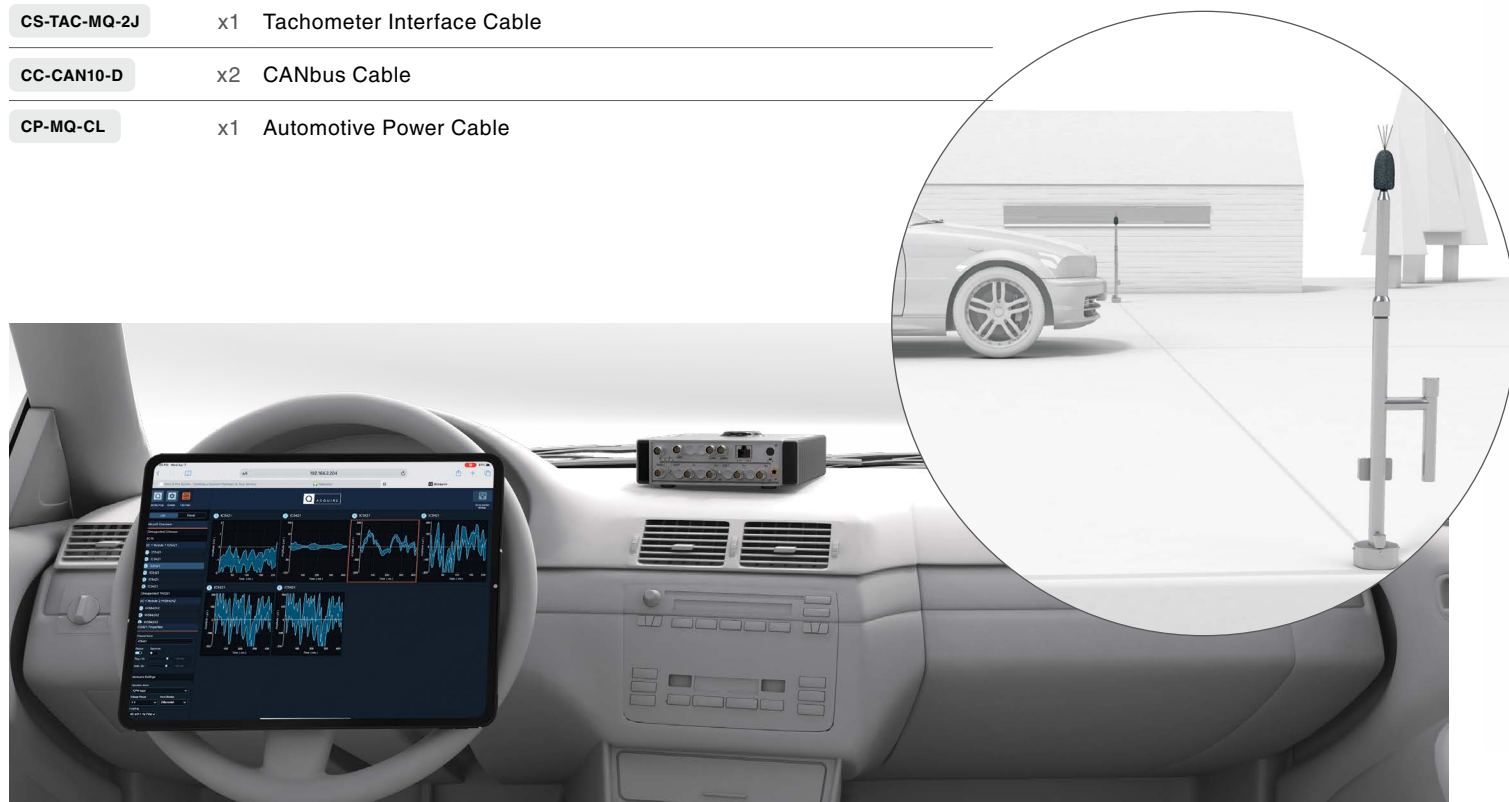

BENCHTOP TEST SYSTEM

For Structural Data Acquisition Applications. Measure with a MICROQ populated with 8x Input Channels of ICP® / Strain / Voltage

CHOOSE

MICROQ†

ADD QUANTUSERIES I/O MODULES

MD-WSB42X x2 Advanced Bridge / ICP® / Voltage Input Module
8x Channels IPC® / Strain / Voltage Input

ADD CABLES

CS-WSB-D x8 Signal Cable for MD-WSB42(X)

CS-AIO-J x8 Voltage / ICP® Signal Cable



More channels.

IN ONE SYSTEM OR DISTRIBUTED

The DECAQ is a highly configurable platform for a wide variety of applications. It is available in several different sizes and configurations; from battery powered for field measurements, to large rack mounted Systems in test cells. Combined with the wide range of interchangeable **QuantusSeries** I/O Modules, the DECAQ supports almost any testing scenario.

Multiple DECAQ Systems can be combined into a single System using PTP synchronization. GPS Synchronization is also available for remote Systems.



The DECAQ is available with battery power for up to 2 hours of field operation, internal SSD, and WiFi communications. It is tailored for both general use and field tests. 2, 3, 4, 6 and 10-slot chassis are available.



The DECAQ Lean supports a single battery for UPS function and is focused on lab or test cell configurations. 4, 6, and 10-slot chassis are available.



#Lean

72-192 CHANNELS

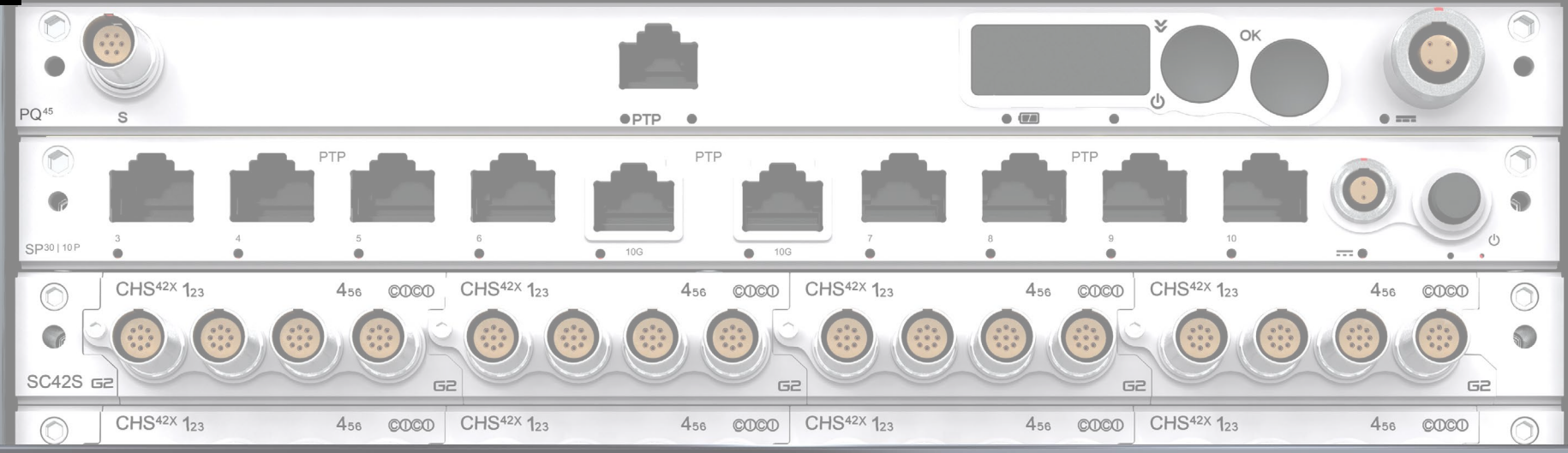

48-120 CHANNELS

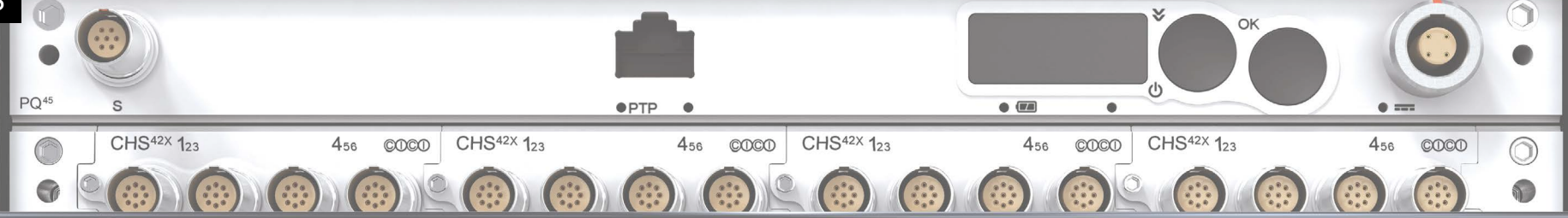

24-72 CHANNELS



16-48 CHANNELS

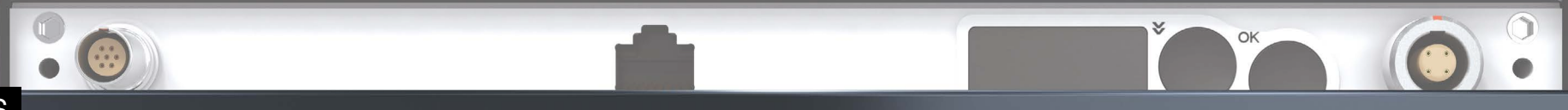

12-24 CHANNELS



Upgrade to the new DecaQ

Re-use selected Modules and Signal Conditioning boards (SCs)

45 SERIES

IMPROVED PERFORMANCE AND ENHANCED FEATURES

QUANTUS SOFTWARE

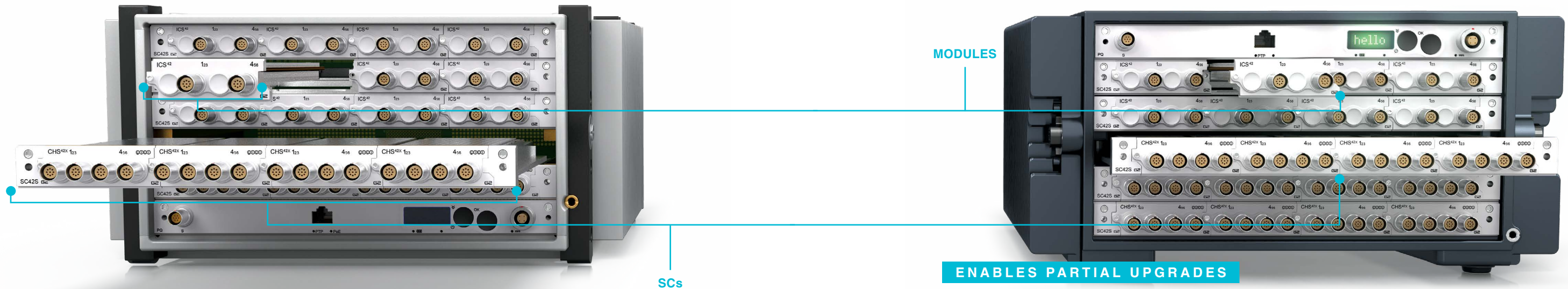

book your

Discover Call

today.

to see how you can upgrade your system



The DECAQ mainframe now supports swappable long-life batteries for running tests in the field. It also supports moving many of your existing modules into this updated platform. The upgraded PQ45 controller supports more channels at higher sample rates.

2 HOURS BATTERY LIFE



Extended Warranty

By performing an annual calibration, a new system's warranty may be extended up to 10 years. Existing systems and moved modules are also eligible to rejoin this extended warranty program. Contact MECALC for details.

COMPARISON

SYSTEM OPTIONS

SLOT NUMBER	DESCRIPTION	ITEM NUMBER - DECAQ AND DECAQL
02-slot	System and Controller	DECAQ-02
03-slot	System and Controller	DECAQ-03
04-slot	System and Controller	DECAQ-04
06-slot	System and Controller	DECAQ-06
10-slot	System and Controller	DECAQ-10

QUANTUSSOFTWARE

	DECAQt	DECAQ AND DECAQL
QServer API	✓	✓
QAcquire Application Software	✓	✓
Multi boot		✓

POWER SUPPLY AND CONTROLLER

SPECIFICATION	DECAQt	DECAQ AND DECAQL
Combined VMEbus System Controller Master, Arbiter and Interrupt Handler	✓	✓
Supports 2eVME standard	✓	✓
Ethernet	1000BASE-T	1000BASE-T
Advanced computational ability	✓	✓
VMEbus Power Supply	✓	✓
Power processor with memory	1/3 GHz PowerPC, 1 Gbyte DDR2 Memory	1.5 GHz processor (4-cores) with 2 GB DDR4 Memory

SYNCHRONIZATION

SPECIFICATION	DESCRIPTION	DECAQt	DECAQ AND DECAQL
PTP	Precision Time Protocol (PTP IEEE 1588-2008). Synchronize Systems to within 50 ns of each other. Add an internal PTP switch to enable synchronization.	✓	✓
GPS	Add a GPS42 QModule for timing and position data, allowing any number of Systems to form a larger System through GPS synchronization. Synchronization with drift compensation synchronizes Systems within 500 ns of each other.	✓	✓

ENVIRONMENTAL FEATURES

SPECIFICATION	DECAQ AND DECAQL
Humidity non-condensing	90 % RH
Shock ¹ 11 ms duration	55 g vertical 40 g Transverse and Longitudinal
Random Vibration ² 300 to 1000 Hz	0.1 g ² /Hz Vertical 0.05 g ² /Hz Transverse and Longitudinal

¹ According to MIL-STD-810G Method 516.6, Procedure V. 1 g = 516.6 m/s²

² According to MIL-STD-810G Method 514.6, Procedure I. 1 g = 514.6 m/s²

POWER OPTIONS

SPECIFICATION	DECAQt	DECAQ	DECAQL
Typical power input source	External DC supply	External DC supply, Internal Battery Pack	External DC supply, Internal Battery Pack
Power Input	10-30 VDC	10-30 VDC	10-30 VDC
Power adapter	Included in all Systems	Included with all Systems	Included with all Systems
Battery	N/A	Supports user swappable batteries for up to 2-hours of use. DQ02, DQ03 supports 1 battery, DQ04 supports 1-2 batteries, DQ06 supports 1-3 batteries, and DQ10 supports 1-5 batteries.	Supports one user swappable battery for UPS function. DQ04L, DQ06L, DQ10L support 1 battery.

COOLING

All DECAQ Systems are designed to operate in a wide range of environmental conditions. To keep Systems cool, aluminum is used to efficiently conduct heat from electronic components to the exterior of the chassis. The heat is then transferred from the external fins to the surrounding air using convection.

Larger chassis sizes and System configurations use an external fan to draw air across the external fins. For low noise acoustic applications, fans can be turned off to prevent interference with the measurement.

No DECAQ System chassis has internal airflow. This keeps the interior clean and the interior temperature stable, greatly extending the life of the electronics

Conduction through DECAQ DECAQ-02 | 03 | 04 | 06 | 10

Natural Convection through External Cooling DECAQ-02 | 03 | 04 | 06 | 10

Forced Convection through External Fan DECAQ-04 | 06 | 10

DATA THROUGHPUT

When configuring a System, the overall data throughput needs to be evaluated. The table below lists the maximum number of channels supported in a single System for some common sample rates.

Please note: Sample rates are configured on a channel-by-channel basis and many configurations do not fit cleanly into these examples. Contact your local MECALC Technologies office for assistance when configuring a System that does not clearly correlate with the descriptions below.

DECAQ SYSTEMS

SAMPLE RATE	MAX CHANNELS PER SYSTEM	RECOMMENDED SYSTEM
204.8 kHz	Less than 80 Channels	DECAQ-02 04 06
204.8 kHz	Up to 112 Channels	DECAQ-10
176.4 kHz	Up to 128 Channels	DECAQ-10
131.0 kHz	Up to 144 Channels	DECAQ-10
102.4 kHz	Up to 192 Channels	DECAQ-10

*These are examples of the maximum number of channels. For different configurations please contact your sales representative.

#tethered

CONTACT US



ACCESSORIES

The DECAQ is designed with portable measurements in mind. Battery Cartridges may be added to any size mainframe for up to two hours of field measurements. Batteries are interchangeable and may be swapped in the field to support longer measurement tasks.

- Supported in all DECAQ Systems from DQ02 to DQ10
- Easily swappable in the field
- Battery Cartridges comply with flight regulations for a single cartridge installed in a System and two spare cartridges as carry-on luggage.

BATTERY CARTRIDGES

ITEM NUMBER	DESCRIPTION
DQ-BAT	<ul style="list-style-type: none"> - DECAQ battery. - Li-Ion Battery. - 90 Wh Capacity. - Systems come standard with one removable battery.
DECAQ	<ul style="list-style-type: none"> - DECAQ supports one to five user swappable batteries (DQ -BAT). Number of batteries supported is dependent on chassis size. Batteries purchased separately.
DECAQ LEAN	<ul style="list-style-type: none"> - DECAQ Lean supports one user swappable battery (DQ -BAT). Battery purchased separately



Choose the number of batteries required to meet the measurement task.

- No battery – DECAQ is powered by mains power or vehicle power.
- UPS Backup for applications where the primary power source may be intermittent. Install one battery.
(For example: a vehicle's auxiliary power source may be interrupted when starting the engine.)
- Battery powered field measurements are supported by filling all of a System's battery bays with cartridges.
(i.e. 1 cartridge for DQ02 or DQ03, 2 cartridges for DQ04, 3 cartridges for DQ06, and 5 cartridges for DQ10)
- Longer term measurements are possible by periodically swapping cartridges.
(Requires temporary power from a vehicle or mains power source.)

BATTERY CONFIGURATIONS

All DECAQ Systems support one or more batteries. The images below show a System with the back cover removed to access the battery bays. Batteries purchased separately.

SYSTEM	SYSTEM WITH NO BATTERIES INSTALLED	SYSTEM WITH ONE BATTERY INSTALLED	SYSTEM WITH MULTIPLE BATTERIES INSTALLED
DECAQ-02			N/A
DECAQ-03			N/A
DECAQ-04			 <i>Max 2 removable batteries</i>
DECAQ-06			 <i>Max 3 removable batteries</i>
DECAQ-10			 <i>Max 5 removable batteries</i>

Mounts.

MOBILE MOUNTS

MobileMounts optimally secures 2, 3, 4, 6 or 10-slot System, SubModules and cabling with an optional notebook for mobile measurements.



CUSTOM MADE MOBILE MOUNT WITH INTEGRATED BNC CONNECTORS

CONTACT US

RACK MOUNTS

The RackMounts are a compact, machined aluminum RackMounting Kit which house 2, 3, 4, 6 or 10-slot DECAQt chassis.

The chassis has specifically been recessed in each Mounting Kit to ensure that all cables are contained behind the rack's front face. These cables can then be routed to the left and right sides of the chassis.

At the rear, a horizontal brace provides a mounting point for cable connector flanges should this be required. This is useful where a conversion is required between DECAQ chassis connectors and those used by the testing facility.

The sides and rear of the Mount are left open to allow air to enter from the bottom of the rack to cool all mounted DECAQs.

REMOVE FROM RACKMOUNT FOR PORTABLE MEASUREMENTS

AND SECURE BACK TO RACKMOUNT



SEAT FRAMES

The SF10 SeatFrame optimally secures 2, 3, 4 or 6-slot System and a laptop onto a car seat for mobile measurements. It consists of machined aluminum members which can be adjusted to optimally fit the seat, System and laptop.

To prevent sideways movement, the side and rear sleds can be adjusted to best hug the seat. The rear SeatFrame handle can also be adjusted to push against the seat's backrest to prevent it from flipping over. It is strapped to the seat using the seat's safety belt. A laptop is placed on an adjustable base mounted above QuantusSeries Systems.



Transport.

DECAQ TRAVEL CASE

For secured travel, the DECAQ Travel Case keeps your System and its accessories safe in transit. Our injection molded high-end travel case is manufactured from Polypropylene material with an IP 67 rating, carry handles, padlock opportunity, wheels & retractable pull handle for ease of movement. This user-friendly high-end travel case weighs 6 kg - Travel case only.

DECAQ RIGID CASE

Protective rigid cases for transportation over long distances are available for all Mainframe sizes. These robust cases are made of HPX® high-tech plastic and are water, dust and airtight.

Depending on the interior configuration of the transportation case, users have a secure place not only for QuantusSeries Systems, but also for cables, sensors and even a notebook. Smaller cases may be taken on board an airplane as hand luggage.

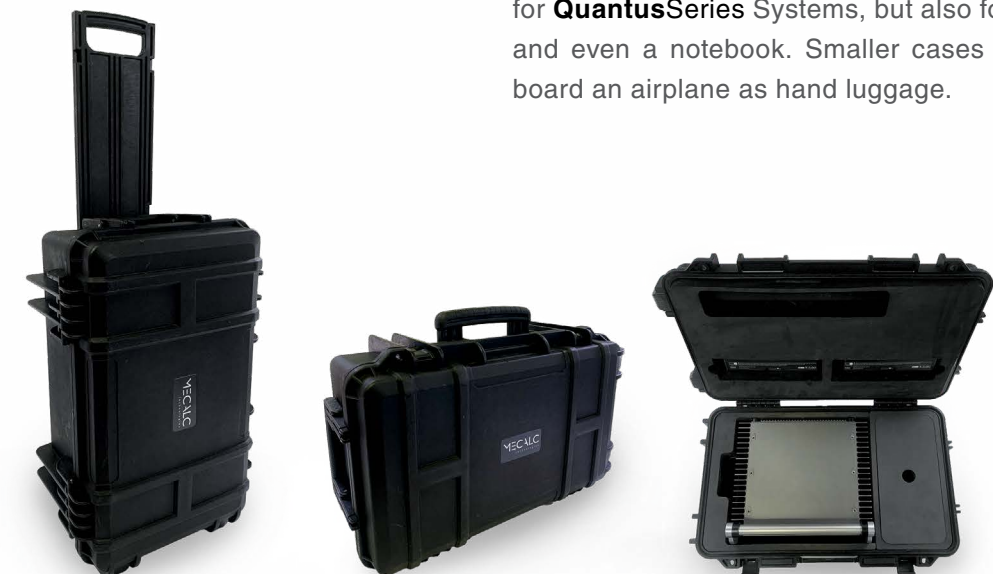

SYNCHRONIZATION

PTP SYNCHRONIZATION:

PTP Synchronization according to the IEEE 1588-2008 standard enables easy expansion across multiple Systems. All Systems are connected to the same network with Ethernet as the communication medium. This concept achieves clock frequency and phase synchronization between multiple Systems.

THE COMBINATION OF THE SP⁴⁵ INTERNAL PTP SWITCH FOR UP TO 8 DECAQs AND PTP ENABLED COMBINED SYSTEM CONTROLLER AND POWER SUPPLY BOARDS, COMPLETES THE PTP CLUSTER.

Cluster HUNDREDS OF CHANNELS

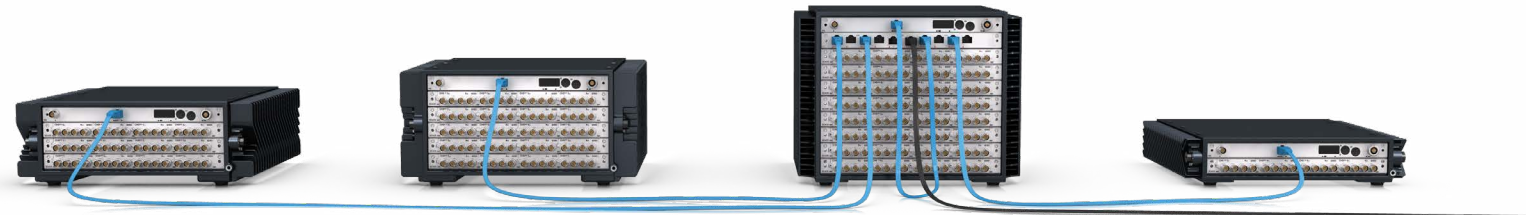

SuperCluster THOUSANDS OF CHANNELS



SIMPLIFIED
SETUP AND CABLING

SYNCHRONIZATION OPTIONS

ITEM NUMBER	DESCRIPTION
QS-SYNC-PTP-S	- Enable PTP Synchronization Slave - One license needed per System
QS-SYNC-PTP-M	- Enable PTP Synchronization Master - One license needed per System
QS-SYNC-GPS	- Enable GPS Synchronization - One license needed per System

SP⁴⁵

Internal PTP Switch for up to 8 Systems

SP45-PTP



The DECAQ PTP Switch (SP⁴⁵) together with a QS-SYNC-PTP-S (PTP Slave) or QS-SYNC-PTP-M (PTP Master) license will enable the synchronization of multiple DECAQ over PTP IEEE 1588-2008.

Add more SP⁴⁵s to expand the configuration and create SuperClusters supporting thousands of channels. PTP Synchronization simplifies cabling and is suited to mobile or rack-mounted configurations.

FEATURES

- 8 x 1 Gb/s PTP aware Ethernet ports synchronizing a Cluster of DECAQ front-ends
- 2 x 10 Gb/s PTP aware Uplink Ethernet ports
- One cable for network communication and synchronization

Note: SP30 will be sold for DECAQ Tethered.

SP30-PTP

SP⁴⁵ PoE

Internal PTP Switch for up to 4 Systems powered by PoE

[CONTACT US](#)

SP45-PoE



The SP⁴⁵ PoE Switch provides Power-over-Ethernet (PoE) to connected DECAQs and MICROQs. PoE is a technique to provide both power and communications to devices using a single Ethernet cable. This is useful in situations where local power is not easily available to support a System. Using PoE further simplifies cabling requirements.

The SP⁴⁵ PoE has been designed to provide the higher power levels needed to support **QuantusSeries** Systems.

FEATURES

- 4 x 1 Gb/s PTP aware Power-over-Ethernet ports synchronizing a Cluster of DECAQ front-ends
- 2 x 10 Gb/s PTP aware Uplink Ethernet ports
- One cable for network communication and synchronization

BUILD YOUR SYSTEM

The **QuantusSeries DECAQ** is configurable for a wide range of applications. Select options for power and other built-in options, as well as interchangeable **QuantusSeries I/O Modules**, to complete the System. Built-in options should be added at the time of original purchase, adding these options later will require a new controller and factory service. I/O Modules are easily added to a System at any time.

Multiple **DECAQ** and **MICROQ** Systems can be combined into a single larger System. These Systems are synchronized using an SP45 or PTP Switch.

DECAQt prices are for new Systems. For replacement Systems, or when moving I/O Modules to **QuantusSeries**, add 30% to 2-Year Warranty list prices. Only 2-year warranties are offered for replacement or moving module Systems.

When building your System, first talk through your measurement application requirements to help decide on both the I/O Modules needed as well as the System size and its power options.

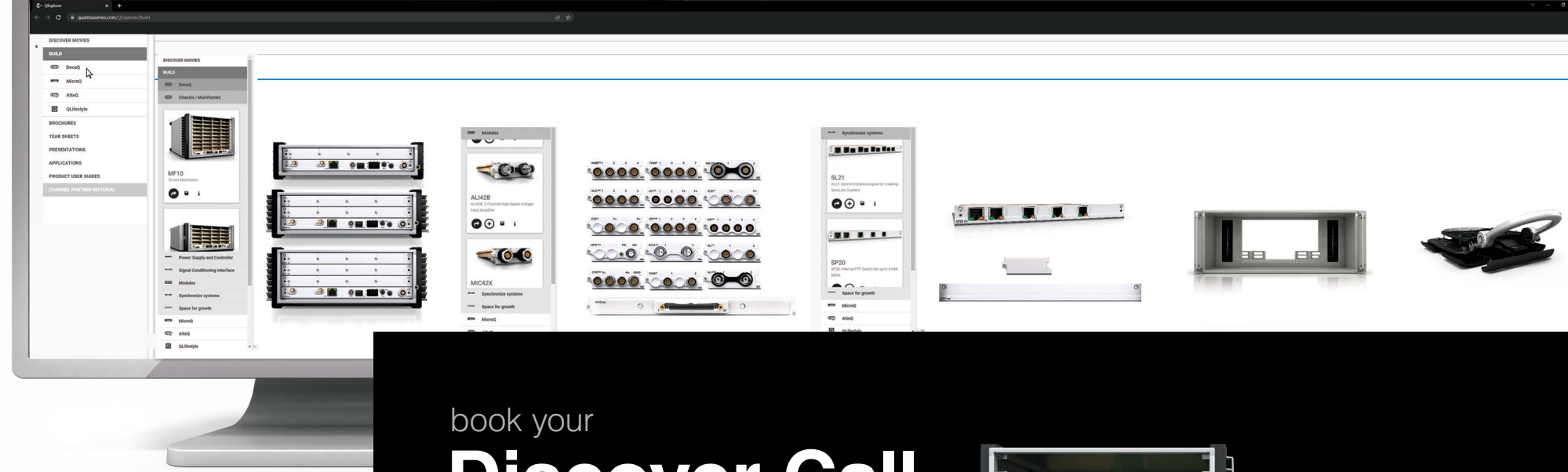

book your
Discover Call
today.



CHOOSE

1. CHOOSE DECAQ INDEPENDENT OR DECAQT TETHERED

DECAQ Systems are available with options for Battery Power, Wi-Fi Communications, and Internal Data Storage. The **DECAQt** is the Tethered option and is not available with these options and is best suited for test stands and laboratory use.

DECAQ options:

- DQ-SSD128 - Internal 128 GB SSD, or
- DQ-SSD128-WIFI - Internal 128 GB SSD and WiFi Connectivity
- DT-BAT - **DECAQ** Battery

2. QUANTUSSERIES I/O MODULES AND COMPOUND MODULES

Configure your System by choosing **QuantusSeries** I/O Modules and Compound Modules for your application. I/O Modules may be added and swapped removed in the field as needed, allowing a single System to be configured for a wide range of applications.

3. SYSTEM SIZE

The size of your System depends on the number of **QuantusSeries** I/O Modules and/or Compound Modules required for your applications. Choose between a 2-slot, 3-slot, 4-slot, 6-slot, or 10-slot chassis. One slot is used for the System controller, the other slots are available for I/O Modules. Each slot supports up to four I/O Modules or one Compound Module.

ADD

4. POWER CABLES AND/OR SPARES

The **DECAQt** comes standard with a power adapter. Additional power cable options are available to enhance your measurement setup.

5. RELATED SIGNAL CABLES AND SUBMODULES

QuantusSeries I/O Modules and Compound Modules are often paired with specialized signal cables and SubModules created to interface with the Module and seamlessly integrate into the user's measurement architecture. Add your related signal cables and SubModules.

6. MODULE SLOT COVERS AND VMEBUS CLOSE-OUTS

Add Module slot covers and VMEbus close-outs for any unused Module and/or Signal Conditioning board slots. These protect the System from environmental damage.

7. SYNCHRONIZE

Add a PTP switch to synchronize multiple **DECAQ** Systems. The switch uses one slot in a chassis.

Add License for PTP (Precision Time Protocol) QS-SYNC-PTP-S. PTP Synchronization must be purchased for each System in a synchronized group. The package includes up to 6 hours of technical support.

8. ACCESSORIES

Add accessories such as the RackMount and SeatFrame to customize your measurement setup.

9. CALIBRATION AND WARRANTY SERVICES

Calibration services improve the System's performance and ensure it works optimally for longer. Add these services and adjust the warranty period as needed.

CUSTOM CABLES

MECALC will design and manufacture custom cables on request.

EXAMPLES

DATA THROUGHPUT ON THE DECAQ AND DECAQL

With current supported sample rates

SAMPLE RATE	MAX CHANNELS PER SYSTEM	RECOMMENDED SYSTEM
204.8 kHz	Less than 80 Channels	DECAQ-02 04 06
204.8 kHz	Up to 112 Channels	DECAQ-10
176.4 kHz	Up to 128 Channels	DECAQ-10
131.0 kHz	Up to 144 Channels	DECAQ-10
102.4 kHz	Up to 192 Channels	DECAQ-10

**These are examples of the maximum number of channels. For different configurations please contact your sales representative.*

SAMPLING RATE

SYSTEM	DESCRIPTION
DECAQ-02 03 04 06 DECAQL-04 06	- All configurations of I/O Modules supported at full sample rates
DECAQ-10 / DECAQL-10	- Up to 112 channels (28 x 4 channel modules) supported at up to 204.8 kSa/s
	- Up to 128 channels (32 x 4 channel modules) supported at up to 176.4 kSa/s
	- Up to 144 channels (36 x 4 channel modules) supported at up to 131.0 kSa/s
	- Up to 192 channels (32 x 6 channel modules) supported at up to 102.4 kSa/s



DECAQ-03 CONFIGURED FOR AUTOMOTIVE TEST

- 24 channels ICP® at 102.4 kSa/s
- 4 channels ICP® at 204.8 kSa/s
- 4 channels of Tachometer
- 4 channels CAN bus



DECAQL-04 FOR AERO ENGINE TEST

- 40 channels Bridge/ICP® at 204.8 kSa/s
- 4 channels ICP® at 204.8 kSa/s
- 4 channels of Tachometer



TWO DECAQL-06 FOR AERO ENGINE TEST

- 136 channels Bridge/ICP® at 204.8 kSa/s
- 8 channels Differential Charge, at 204.8 kSa/s
- 4 channels ICP® at 204.8 kSa/s
- 4 channels of Tachometer



DECAQL-10 FOR LARGE CHANNEL COUNT DATA ACQUISITION / SATELLITE TEST

- 192 channels ICP® at 102.4 kSa/s

CUSTOM CABLES

MECALC will design and manufacture custom cables on request.

book your
Discover Call
today.



EXAMPLES

The DECAQ provides an open platform for you to configure a System that exactly matches your measurement requirements. Speak to your product expert about your application needs and build a hand-picked solution to match. The examples below show how a specific measurement can be supported by a tailored DECAQ solution.

PORTABLE NVH TEST SYSTEM

Collect comprehensive data for prototype testing, with 36 ICP® channels for accelerometers and microphones, 2 Tachometer channels and 2 CAN / CAN FD channels.

CHOOSE SYSTEM AND CONTROLLER

DECAQ-03	
MD-SC42S	x2 Advanced Signal Conditioning Interface

ADD QUANTUSSERIES I/O MODULES AND SIGNAL CABLES

MD-ICS42S	x6 ICP® / Voltage Input Module 36 ICP® Input Channels
CS-ICS-3J 500	x12 Three-BNC Signal Cable
MD-ICT42S	x1 Advanced Tachometer Module 2x Tachometer Channels 2x Additional ICP® Channels
CS-TAC-J 1000	x2 Tachometer Signal Cable
CS-ICPS-J 1000	x2 ICP® / Voltage Signal Cable
MD-CAN42S	x1 CANbus Interface Module 2x CAN / CAN FD Channels
CC-CAN10-D 300	x2 CANbus Cable

ADD POWER OPTIONS

CP-DQ-CL 2000	x1 Automotive Power Adapter for DECAQ Systems
DQ-BAT	x1 DECAQ Battery

ADD MOUNTING OPTIONS

SF10-SM	x1 Automotive Mount Package for DECAQ 02-06 Systems
----------------	---



TEST CELLS

AERO-ENGINE TEST CELL

Measure Aero-Engines in Test Cells with 144 Bridge/ICP®/Voltage Channels, 8 Differential Strain Channels and 4 Tachometer Channels with synchronized Systems.

CHOOSE SYSTEM AND CONTROLLER

DECAQL-04	
SP45	x1 1GB Transparent PTP Switch
SC42S	x11 Advanced Signal Conditioning Interface

ADD QUANTUSSERIES I/O MODULES AND SIGNAL CABLES

MD-WSB42X	x36 Advanced Bridge / ICP® / Voltage Input Module 144x CS-WSB-D 2000 – WSB Signal Cable 144x CS-AIO-J 500 – ICP®/Voltage Signal Cable
MD-DCH42S	x4 Differential Charge Input Module
MD-ICT42S	x2 Advanced Tachometer Module 4x Tachometer Channels 4x Additional ICP® Channels
CS-TAC-J 1000	x4 Tachometer Signal Cable
CS-ICPS-J 1000	x4 ICP® / Voltage Signal Cable

ADD I/O MODULES COVER

MBL	x2 Module Blank (to cover empty I/O Module slot)
------------	--

ADD MOUNTING OPTIONS

RM-DQ02-04	x4 19 inch RackMount Kit for DECAQ 02-04
-------------------	--



I/O MODULES.



CHOOSE FROM OUR BROAD RANGE OF MODULES

Each Module is optimized for a specific task while some combine different functions in one Module. Modules are continuously under development to accommodate new features and the latest technologies.

All Modules include the following features:

- 50 V galvanic isolation from one Module to another
- Automatic internal calibration capability
- All settings are software configurable
- Very high channel density
- Excellent signal to noise performance
- Excellent spurious free-dynamic range, total harmonic distortion and crosstalk
- Finely tuned for the best performance at the lowest possible power
- Protection to accommodate both transient and continuous over-voltages
- Strong Electromagnetic Interference (EMI) screening for lower noise floor
- Firmware protection from excessive external EMI events
- Low power consumption



SC42S

Signal Conditioning Board
VMEbus Signal Conditioning Engine and Infrastructure

SC42S

The SC42S board provides the isolated power, signal processing, and mechanical infrastructure for up to four signal I/O Modules. It is a highly advanced board using 5 powerful 24-bit DSPs to process large volumes of data transferred between each Module and the VMEbus.

It also provides isolated power, sample timing infrastructure, and the internal communications interface for the I/O Modules. The easy interchangeability of I/O Modules is provided by the SC42S infrastructure. Modules are plugged into the SC42S and can be inserted and removed without removing the SC42S board itself.

WHERE USED:

- In any slot of all Systems except slot 1 which is reserved for the VMEbus System Controller and Power Supply

FEATURES

VMEbus slave and interrupter	4 isolated power supplies, one per Module
Supports the latest 2eVME specifications	Houses the Module's self-calibration engine
Mechanics to accommodate 4 Modules	Thermally optimized and encased in aluminum
Provides accurate timing infrastructure for 4 Modules	For high-speed multi-channel measurements
5 separate 24-bit DSPs, one per Module and one on the board	-20 °C 4 °F min temperature 55 °C 131 °F max temperature



MODULE COVER - MBL

Module Covers need to be purchased for any empty Module slots on the SC42S. These covers protect the System from any environmental damage that might take place when the Module slots are not in use.

ITEM NUMBER	DESCRIPTION
MBL	- Module Blank. - Covers empty I/O Module slot



SLOT CLOSEOUT FOR DECAQ

All empty DECAQ slots need to be closed to protect them from possible environmental harm. The DQ-VB10 provides a VMEbus closeout for empty DECAQ slots.

ITEM NUMBER	DESCRIPTION
DQ-VB10	- The DQ-VB10 provides a VMEbus closeout for unpopulated DECAQ slots (required)



Signal Conditioning Channels

ANALOG

PARAMETER	MAXIMUM DATA RATE	MODULE	MODULE DESCRIPTION
±10 V voltage input	51.2 kSa/s	ICS ⁴² L	6 channel Voltage Input
	409.6 kSa/s	ALI ⁴² B	2 channel Voltage Input
ICP [®] based microphones, accelerometers, load cells and pressure sensors ±10 V voltage input	51.2 kSa/s	WSB ⁴²	4 channel Bridge / ICP [®] / Voltage Input
		ICS ⁴²	6 channel ICP [®] / Voltage Input
	204.8 kSa/s	CHS ⁴² X	6 channel Charge / ICP [®] / Voltage Input
		ICT ⁴² S	2 channel ICP [®] / Voltage Input
		ICP ⁴² S	4 channel ICP [®] / Voltage Input
		MIC ⁴² X	2 channel Microphone / ICP [®] / Voltage Input
		WSB ⁴² X	4 channel Bridge / ICP [®] / Voltage Input
		CHM ⁴² X	4 channel Charge / ICP [®] / Voltage Input with Buffered Outputs
±60 V voltage input	204.8 kSa/s	ICT ⁴² S	2 channel Tacho / ICP [®] / Voltage Input
		ICP ⁴² S	4 channel ICP [®] / Voltage Input
Tacho pulse input with 4.9 MSa/s Scope Mode	700 kPulse/s ¹	ICT ⁴² S	2 channel Tacho
Piezoelectric based accelerometers, load cells, etc. (Single-Ended)	102.4 kSa/s	CHS ⁴² X	6 channel Charge / ICP [®] / Voltage Input
	204.8 kSa/s	CHG ⁴² S	4 channel Charge Input
		CHM ⁴² X	4 channel Charge / ICP [®] / Voltage Input with Buffered Outputs
Piezoelectric based accelerometers, load cells, etc. (Differential)	204.8 kSa/s	DCH ⁴² S	2 channel Differential Charge Input
E, J, K, T and U thermocouples as well as Pt100 sensors ±10 V voltage input	6.4 kSa/s	THM ⁴²	8 channel Thermocouple / Pt100 / Voltage Input
Current and Voltage excited strain gauges including dynamic strain. load cells, pressure sensors, strain based accelerometers, inductive displacement (LVDT) and rope displacement sensors ±10 V voltage input	51.2 kSa/s	WSB ⁴²	4 channel Bridge / ICP [®] / Voltage Input
	204.8 kSa/s	WSB ⁴² X	4 channel Bridge / ICP [®] / Voltage Input
Bridge and Resistive Sensors used in Pyro-Shock / Mechanical Shock ±5 V voltage input	1.25 MSa/s	ALI ²⁵ @ 1250	2 channel Bridge / ICP [®] / Voltage Input
	2.5 MSa/s	ALI ²⁵ @ 2500	
	5 MSa/s	ALI ²⁵	
Acoustic Camera with ICP [®] and ±10 V voltage input	102.4 kSa/s	ACM ⁴²	24 channel Acoustic Camera
200 V or non-polarized microphones	204.8 kSa/s	MIC ⁴² X	2 channel Microphone / ICP [®] / Voltage Input



TIME, POSITION AND COMMUNICATION

GPS	10 Hz	GPS ⁴² S	GPS Receiver for Time Synchronization and Position
CAN	2 Mbit/s (simultaneous)	CAN ⁴² S	2 channel CAN bus Interface

OUTPUT

±10 V Signal Outputs: DC, Sine, Triangle, Square, and White Noise	204.8 kSa/s	ALO ⁴² S	4 channel Analog Output
---	-------------	---------------------	-------------------------

MONITORING

Buffered outputs for external monitoring of the conditioned input signals	98 kHz bandwidth	ALO ⁴² S	4 channel Buffered Analog Output
	204.8 kSa/s	CHM ⁴² X	4 channel Charge / ICP [®] / Voltage Input with Buffered Outputs
	2.375 MHz bandwidth	ALI ²⁵	2 channel Buffered Analog Output

Note 1: Pulse rate for sum of both channels

ICP42S

4 Channel ICP® and Voltage Input Amplifier

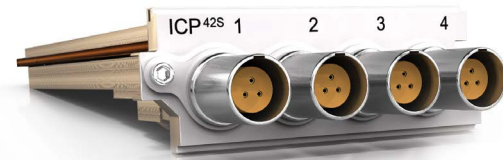

MD-ICP42S

The ICP42S Module can be used with ICP® based accelerometers, force and pressure sensors as well as to measure analog voltages. All 4 channels operate independently of each other, each with their own setting of mode, gain and coupling.

WHERE USED:

- With any ICP® based sensor commonly used to measure vibration, acceleration, force or pressure
- With any voltage source up to ±60 V in voltage input mode

FEATURES

4 Channels	Short and open circuit cable monitoring
Supports TEDS IEEE 1451.4 V0.9, V1.0 (Class 1)	Pre-and post-filter overflow monitoring
24-bit resolution, 204.8 kSa/s sampling rate per channel, 100 kHz bandwidth	Signal integrity circuit continuously monitors the input and disconnects sensitive circuits during overload conditions
< 0.2° @ 10 kHz phase accuracy between channels of the same or any other Module	Selectable low and high pass digital filters
2 modes of operation:	3 input biasing options available:
- ICP® mode with 4 mA, 8 mA, or 12 mA constant current at 24 V excitation	- Differential or Balanced Float
- Voltage input mode with AC or DC coupling	- Single-Ended or Unbalanced Float
	- Single-Ended or Unbalanced Ground
2 MΩ differential and 1 MΩ single-ended input resistance	Low power consumption
± (100 mV, 1 V, 10 V, 60 V) input ranges	LEMO® 3-pin EHG.0B connectors

RELATED SIGNAL CABLE

One per channel:

ITEM NUMBER	DESCRIPTION
CS-ICPS-J	<ul style="list-style-type: none"> - Voltage / ICP® Sensor Cable. - Used to connect direct Voltage and ICP® sensors - 3-pin LEMO® to BNC Jack Connector - Length: 1 m



ICS42

6 Channel ICP® and Voltage Input Amplifier

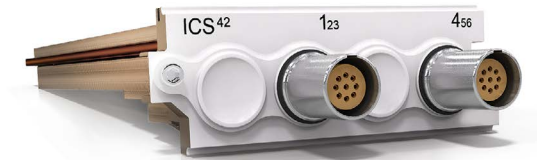

MD-ICS42

The ICS42 Module can be used with ICP® based accelerometers, force and pressure sensors, as well as to measure analog voltages. All 6 channels can operate independently of each other, each with their own setting of mode, gain and coupling.

WHERE USED:

- With any ICP® based sensor commonly used to measure vibration, acceleration, force or pressure
- With any voltage source up to ±10 V in voltage input mode

FEATURES

6 Channels	± (100 mV, 1 V, 10 V) input ranges
Supports TEDS IEEE 1451.4 V0.9, V1.0 (Class 1)	Highly configurable to accommodate single-ended and triaxial sensors
24-bit resolution, 102.4 kSa/s sampling rate per channel, 44.3 kHz bandwidth	Supports a number of known industry triaxial cables
< 0.2° @ 10 kHz phase accuracy when in similar range	Short and open circuit cable monitoring
2 modes of operation:	Selectable low and high pass digital filters
- ICP® mode with 4 mA constant current at 24 V excitation	
- Voltage input mode with AC or DC coupling	
3 input biasing options available:	2 MΩ differential and 1 MΩ single-ended input resistance
- Differential or Balanced Float	
- Single-Ended or Unbalanced Float	
- Single-Ended or Unbalanced Ground	
	Low power consumption
	LEMO® 9-pin EHG.0B connectors

MIC⁴²X

2 Channel Microphone, ICP® and Voltage Input Amplifier

MD-MIC42X



In addition to providing excellent performance for microphone measurements, the MIC⁴²X Module also offers ICP® and voltage input modes.

WHERE USED:

- With any 200 V or self-polarized microphones with pre-amplifier
- With any ICP® based sensor commonly used to measure vibration, acceleration, force or pressure
- With any voltage source up to ±12 V in voltage input mode

FEATURES

2 Channels	Exceptionally low distortion and noise design
Supports TEDS IEEE 1451.4 V0.9, V1.0 (Class 1 and 2)	Software-selectable connection of cable shield to CGND
24-bit resolution, 204.8 kSa/s sampling rate per channel, 100 Hz bandwidth	Microphone calibration output to inject test signals into microphone pre-amplifiers
< 0.2° @ 10 kHz phase accuracy when in similar range	Short and open circuit cable monitoring
3 modes of operation: <ul style="list-style-type: none"> - Microphone mode with 200 V or self-polarized microphone capsules with pre-amplifier - ICP® mode with 4 mA, 8 mA, or 12 mA constant current at 24 V excitation - Voltage input mode with AC or DC coupling 	Signal integrity circuit continuously monitors the input and disconnects sensitive circuits during overload conditions
3 input biasing options available: <ul style="list-style-type: none"> - Differential or Balanced Float - Single-Ended or Unbalanced Float - Single-Ended or Unbalanced Ground 	Pre-amplifier Excitation Short Circuit protection
± (120 mV, 1.2 V, 12 V) input ranges	Pre-and post-filter overflow monitoring
± 14.5 V microphone pre-amplifier excitation voltage	Low power consumption
0 or 200 V polarization output	LEMO® 7-pin EGG.1B connectors

RELATED SIGNAL CABLE

One per channel:

ITEM NUMBER	DESCRIPTION
-------------	-------------

CS-MIC-J

- Voltage / ICP® Sensor Cable. Connect direct voltage and ICP® sensors. 7-pin LEMO® to a single BNC Jack connector.
- Length: 1 m



CHS⁴² X

6 Channel Charge or ICP® and Voltage Input Amplifier

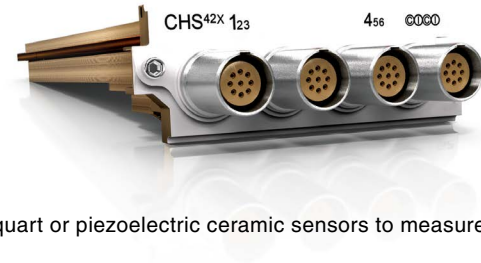

MD-CHS42X

The CHS⁴²X Module can be used with ICP® based accelerometers, force and pressure sensors, quartz or piezoelectric ceramic sensors to measure analog voltages.

WHERE USED:

- With any ICP® based sensor commonly used to measure vibration, acceleration, force or pressure
- With piezoelectric sensors commonly used to measure vibration, acceleration, force, torque and pressure
- With any voltage source up to ±10 V in voltage input mode

FEATURES: ICP® / VOLTAGE MODE

6 Channels	Short and open circuit cable monitoring
Supports TEDS IEEE 1451.4 V0.9, V1.0 (Class 1)	Supports a number of known industry triaxial cables
24-bit resolution, 102.4 kSa/s sampling rate per channel, 44.3 kHz bandwidth	Signal integrity circuit continuously monitors the input and disconnects sensitive circuits during overload conditions
ICP® mode with 4 mA constant current at 24 V excitation	Pre-and post-filter overflow monitoring
Voltage input mode with AC or DC coupling	Selectable low and high pass digital filters
Highly configurable to accommodate single-ended and triaxial sensors	Low power consumption
	LEMO® 9-pin EHG.0B connectors

FEATURES: CHARGE

6 Channels	Low power consumption
24-bit resolution, 102.4 kSa/s sampling rate per channel, 49 kHz bandwidth	High input impedance
Drift is lower than 4 mV/h at any sensitivity and gain	Selectable low and high pass digital filters
The cable shield can be connected or disconnected from the Module ground	LEMO® 9-pin EHG.0B connectors

RELATED SUBMODULES, SIGNAL CABLE AND RACKMOUNT

One of any of the following, per 3 ICS⁴² channels:

ITEM NUMBER	DESCRIPTION	
SM-TriBNC	<ul style="list-style-type: none"> - Split signals from 9-pin LEMO® to TriBNC Jack Connector (3 BNC connectors). - Optional lengths: 300 mm 500 mm 1200 mm 	
SM-TriSMB	<ul style="list-style-type: none"> - Split signals from a 9-pin LEMO® to TriSMB Jack Connector (3 SMB connectors). - Optional lengths: 500 mm 1.2 m 	
CS-ICS-3J	<ul style="list-style-type: none"> - Split signals from a 9-pin LEMO® to three independent BNC Jack connectors - Supports 3 ICP® / Voltage Input Channels on MD-ICS42. - Optional lengths: 500 mm 1.2 m 	

CHM⁴²X

4 Channels of Charge, ICP®, or Voltage with Buffered Outputs
24-bit resolution, 204.8 kSa/s, 88.6 kHz bandwidth

MD-CHM45

The CHM⁴²X Module is used with Piezoelectric and ICP® based accelerometers, force, and pressure sensors. All 4 channels operate independently of each other, each with its own settings for mode, gain, and coupling. Each input channel has a buffered low noise output channel for monitoring or acquisition of sensor data via a secondary System.

WHERE USED:

- With any ICP® based sensor commonly used to measure vibration, acceleration, force or pressure
- With piezoelectric sensors commonly used to measure vibration, acceleration, force, torque and pressure



FEATURES

4 channels	Maximum charge input of ±1 000 000 pC
3 modes of operation:	2 input biasing options available:
- ICP® mode with 4 mA or 8 mA constant current at 24 V excitation	- Differential or Balanced, Float or Grounded
- Charge input mode with sensitivity range settings	- Single-Ended or Unbalanced, Float or Grounded
- Voltage input mode with AC or DC coupling	
ICP®, Charge or Voltage mode is software selectable for each channel	The cable shield can be disconnected from the Module ground (<i>Charge</i>)
4 buffered output channels of conditioned signal inputs	Short and open circuit cable monitoring (<i>ICP® and Voltage</i>)
Supports TEDS IEEE 1451.4 V0.9, V1.0 (Class 1)	Signal integrity circuit continuously monitors the input and disconnects sensitive circuits during overload conditions
24-bit resolution, 204.8 kSa/s sampling rate per channel, 88.6 kHz bandwidth	Selectable low and high pass digital filters
<0.2° @ 10 kHz phase accuracy (<i>ICP® and Voltage</i>)	2 MΩ differential and 1 MΩ single-ended input resistance
<0.5° @ 10 kHz phase accuracy (<i>Charge</i>)	Input channels use MMCX connectors
±(10 V, 1 V and 100 mV) input ranges	Monitoring channels use 1 LEMO® 9-pin EHG.0B
3 Sensitivity settings of 1 mV/pC, 0.1 mV/pC and 0.01 mV/pC for charge inputs	

DCH⁴²S

2 Channels of Differential Charge
24-bit resolution, 204.8 kSa/s, 90 kHz bandwidth

MD-DCH42S

The DCH⁴²S Module has 2 independent differential input channels for Quartz or piezoelectric ceramic sensors. These sensors are typically used when improved signal performance, such as lower noise and low distortion, is required, or where high temperature and nuclear radiation prevents the use of ICP® based sensors. A differential charge measurement also offers further noise immunity and higher bandwidth, which makes it particularly useful for applications using long cables.

WHERE USED:

- With piezoelectric sensors commonly used to measure vibration, acceleration, force, torque and pressure
- Where long cables are required necessitating the use of balanced twisted pair cables



FEATURES

2 Channels	Maximum charge input ranges from ±10 000 pC to ±100 000 pC in Single-Ended mode and from ±5000 pC to ±50 000 pC in Differential mode
24-bit resolution, 204.8 kSa/s sampling rate per channel, 90 kHz bandwidth	Low discharge time constant provides between 0.016 Hz and 1.6 Hz high pass frequency (-3 dB), depending on mode
< 0.5° @ 10 kHz phase accuracy when in similar range	Selectable low and high pass digital filters
2 modes of operation:	Over voltage detection on front-end input signals
- Single-Ended	
- Differential	
2 sensitivity settings of 0.1 mV/pC and 1 mV/pC when in Single-Ended mode	Amphenol 31-2225 Twin BNC connectors
2 sensitivity settings of 0.2 mV/pC and 2 mV/pC when in Differential mode	Low power consumption
± (100 mV, 1 V, 10 V) input ranges	

ICT^{42S} S

Advanced 2 Channel ICP® / Voltage Input Amplifier
with 2 Channel Tacho Input Amplifier

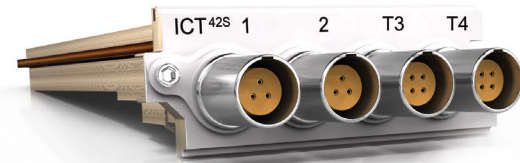

MD-ICT42S

The ICT^{42S} is a hybrid Module which combines 2 channels from the ICP^{42S} Module with 2 Tacho input channels. The Tacho channels provide Tacho period measurements with a 20 ns resolution, sampled when the signal intersects its trigger level settings. Triggering of Tacho signals can be set for rising or falling edges with adjustable hysteresis while additionally providing AC coupling for sensors with varying DC voltage offsets. A high speed 4.9 MSa/s scope mode is provided to view the Tacho signals in order to assist with the definition of trigger levels.

WHERE USED:

- With any ICP® based sensor commonly used to measure vibration, acceleration, force or pressure
- With any voltage source up to ±60 V in voltage input mode
- When measuring the pulse rate and time between pulses such as rpm and crank angle

FEATURES: ICP® / VOLTAGE MODE



2 Channels	± (100 mV, 1V, 10 V, 60 V) input ranges
24-bit resolution, 204.8 kSa/s sampling rate per channel, 100 kHz bandwidth	Short and open circuit cable monitoring
< 0.2° @ 10 kHz phase accuracy between channels of the same or any other Module	Signal integrity circuit continuously monitors the input and disconnects sensitive circuits during overload conditions
2 modes of operation: - ICP® mode with 4 mA, 8 mA, or 12 mA constant current at 24 V excitation - Voltage input mode with AC or DC coupling	3 input biasing options available: - Differential or Balanced Float - Single-Ended or Unbalanced Float - Single-Ended or Unbalanced Ground
Pre-and post-filter overflow monitoring	Selectable low and high pass digital filters
2 MΩ differential and 1 MΩ single-ended input resistance	Low power consumption
	LEMO® 3-pin EHG.0B connectors

FEATURES: TACHO

2 Channels	Triggering on the n'th edge
Tacho input can be DC / AC coupled	Tacho trigger level self-calibration
20 ns (50 MHz) Tacho resolution	Scope mode for each Tacho channel, sampled at 4.9 MSa/s resolution
16-bit Tacho trigger level adjustment	±12 V or 12 V voltage excitation output to Tacho sensor
± (2 V, 12 V, 30 V, 60 V) input ranges	Low power consumption
2 MHz analog bandwidth for all input ranges	700 kPulse/s rate for the sum of the 2 Tacho channels
Adjustable trigger level hysteresis (Schmitt trigger implementation)	LEMO® 4-pin EHG.0B connectors

RELATED SUBMODULE AND SIGNAL CABLE: TACHO

One of the following, per Tacho channel:

ITEM NUMBER	DESCRIPTION	
SM-ICTV11	- Tachometer over-voltage SubModule. Converts 4-pin LEMO® output of a Tacho channel to a BNC Jack connector. Compatible with RM-SM10 1U RackMount. Protects Tachometer inputs from high voltage spikes. - Length: 300 mm	
CS-TAC-J	- Tachometer sensor cable, 4-pin LEMO® output of a Tacho channel to a BNC Jack connector. - Length: 1 m	

RELATED SUBMODULE AND SIGNAL CABLE: ANALOG INPUT

One per ICP® channel:

ITEM NUMBER	DESCRIPTION	
CS-ICPS-J	- Voltage/ICP® Sensor Cable. Connect direct Voltage and ICP® sensors. 3-pin LEMO® to BNC Jack Connector. - Length: 1 m	

TEMPERATURE

VOLTAGE

THM⁴²

8 Channel E, J, K, T and U Thermocouple and Pt100 Input Amplifier



MD-THM42

The THM⁴² Module contains 8 channels for use with any thermocouple type as well as Pt100 sensors. Remote cold-junction compensation is provided through a SubModule (which is thermocouple-type specific) whilst linearization is provided in the Signal Conditioning board. The Module also includes a calibrated 0.2 mA current source for Pt100 sensor excitation. SubModules are available which contain a pair of commonly used miniature E, J, K, T and U thermocouple connectors (other types available upon request) with cold junction circuitry for thermocouple applications. Another SubModule contains a pair of LEMO[®] connectors for Pt100 applications. Any combination of applicable SubModules can be connected to the THM⁴². This Module also includes 8 channels for measuring voltage inputs up to ±10 V.

WHERE USED:

- When measuring E, J, K and T thermocouples (other types available upon request)
- When measuring Pt100 sensors in constant current mode
- With any voltage source up to ±10 V in voltage input mode

FEATURES:

8 Channels	Signal integrity circuit continuously monitors the input and disconnects sensitive circuits during overload conditions
Supports TEDS IEEE 1451.4 V0.9, V1.0 (Class 2)	Selectable low and high pass digital filters
24-bit resolution, 6.4 kSa/s sampling rate per channel, 2.5 kHz bandwidth	2 MΩ differential input resistance
3 modes of operation: <ul style="list-style-type: none"> - Thermocouple - Pt100 based temperature measurement - Voltage input mode 	LEMO [®] 7-pin EHG.0B connectors with 2 channels sharing one connector
± (100 mV and 10 V) input ranges	
0.2 mA Pt100 excitation current	

RELATED SUBMODULES (GENERAL TERMINAL CONNECTORS)

One of any of the following, per 2 channels:

ITEM NUMBER	DESCRIPTION	
SM-THM10-S	<ul style="list-style-type: none"> - 2 channel Thermocouple / Pt100 Screw Terminal SubModule. 7-pin LEMO[®] to 2 screw terminals. Includes cold-junction-compensation sensor with 0.5 °C accuracy. Compatible with the RM-SM10 1U RackMount. - Length: 300 mm. 	
SM-THM10-S20	<ul style="list-style-type: none"> - 2 channel ±20 mA Screw Terminal SubModule. 7-pin LEMO[®] to 2 screw terminals. Converts constant current signals between 4 mA and 20 mA to voltages between 1 V and 5 V. Includes precision 250 Ω resistors to convert current to voltage. Compatible with the RM-SM10 1U RackMount. - Length: 300 mm. 	
SM-THM10-Pt	<ul style="list-style-type: none"> - 2 channel Pt100 Sensor SubModule. 7-pin LEMO[®] to two 4-pin LEMO[®] connectors. Compatible with the RM-SM10 1U RackMount. - Length: 300 mm. 	

RELATED SUBMODULES (DEDICATED THERMOCOUPLE CONNECTORS)

One of any of the following, per 2 channels:

ITEM NUMBER	DESCRIPTION	
SM-THM10-E	<ul style="list-style-type: none"> - 2 channel Type E Thermocouple SubModule. 7-pin LEMO[®] to miniature Thermocouple Jack. Includes a cold-junction-compensation sensor with 0.5 °C accuracy. Chrome/Constant (NiCr/CuNi) alloys. Purple connectors (IEC 584-3 and ANSI MC 96.1). Compatible with the RM-SM10 1U RackMount. - Length: 300 mm 	
SM-THM10-J	<ul style="list-style-type: none"> - 2 channel Type J Thermocouple SubModule. 7-pin LEMO[®] to miniature Thermocouple Jack. Includes a cold-junction-compensation sensor with 0.5 °C accuracy. Iron/Constant (Fe/CuNi) alloys. Black connectors (IEC 584-3 and ANSI MC 96.1). Compatible with the RM-SM10 1U RackMount. - Length: 300 mm 	
SM-THM10-KGr	<ul style="list-style-type: none"> - 2 channel Type K Thermocouple SubModule. 7-pin LEMO[®] to miniature Thermocouple Jack. Includes a cold-junction-compensation sensor with 0.5 °C accuracy. Chrome/Alum (NiCr/NiAl) alloys. Green connectors (IEC 584-3). Compatible with the RM-SM10 1U RackMount. - Length: 300 mm 	
SM-THM10-KY	<ul style="list-style-type: none"> - 2 channel Type K Thermocouple SubModule. 7-pin LEMO[®] to miniature Thermocouple Jack. Includes a cold-junction-compensation sensor with 0.5 °C accuracy. Chrome/Alum (NiCr/NiAl) alloys. Yellow connectors (ANSI MC 96.1). Compatible with the RM-SM10 1U RackMount. - Length: 300 mm 	
SM-THM10-TBI	<ul style="list-style-type: none"> - 2 channel Type T Thermocouple SubModule. 7-pin LEMO[®] to miniature Thermocouple Jack. Includes a cold-junction-compensation sensor with 0.5 °C accuracy. Copper/Constant (Cu/CuNi) alloys. Blue connectors (ANSI MC 96.1). Compatible with the RM-SM10 1U RackMount. - Length: 300 mm 	
SM-THM10-TBr	<ul style="list-style-type: none"> - 2 channel Type T Thermocouple SubModule. 7-pin LEMO[®] to miniature Thermocouple Jack. Includes a cold-junction-compensation sensor with 0.5 °C accuracy. Copper/Constant (Cu/CuNi) alloys. Brown connectors (IEC 584-3). Compatible with the RM-SM10 1U RackMount. - Length: 300 mm 	
SM-THM10-UW	<ul style="list-style-type: none"> - 2 channel Type U Thermocouple SubModule. 7-pin LEMO[®] to miniature Thermocouple Jack. Includes a cold-junction-compensation sensor with 0.5 °C accuracy. Copper/Copper (Cu/Cu) alloys. White connectors. Compatible with the RM-SM10 1U RackMount. - Length: 300 mm 	

WSB⁴²X

4 Channels of Bridge, ICP®, and Voltage
24-bit resolution, 204.8 kSa/s, 100 kHz bandwidth



MD-WSB42X

The WSB⁴²X Module is used with AC and DC bridge measurements including strain gauges configured as full, half, or quarter bridges and inductive displacement transducers (LVDT). The Module offers constant balanced current excitation, voltage excitation, bridge completion resistors, and shunt calibration. The bridge can be balanced on command or a previous balance value can be recalled.

WHERE USED:

- With any strain gauge in quarter, half and full bridge, load cell and pressure transducer
- Inductive displacement transducer (LVDT)
- With any voltage source up to ±10 V in voltage input mode
- Current-excited sensors in 4-wire mode (full bridge or one external element, DC and AC)
- Current-excited sensors in 2-wire mode (dynamic strain only)
- With any ICP® based sensor commonly used to measure vibration, acceleration, force or pressure

FEATURES

4 Channels	< 0.2° @ 10 kHz phase accuracy when in similar range
Supports TEDS IEEE 1451.4 V0.9, V1.0 (Class 1 and 2)	± (10 mV, 100 mV, 1 V, 10 V) input ranges for all modes
24-bit resolution, 204.8 kSa/s sampling rate per channel, 100 kHz bandwidth	Balanced differential signal input, differential voltage-excitation output and balanced sense input
5 MODES OF OPERATION:	≤ 10 kHz AC excitation
Voltage input mode	Full, half and quarter bridge configurations
ICP® mode with 4, 8 or 12 mA constant current at ±12 V excitation	
Bridge voltage-excitation mode:	
<ul style="list-style-type: none"> - 0-6 V (AC or DC) for 350 Ω full bridges - 0-6 V (AC or DC) for 120 Ω and 350 Ω half or quarter bridges - 0-4 V (AC or DC) for 120 Ω full bridges - 8-10 V (DC) for 1 kΩ bridges 	Internal half and quarter bridge completion resistors for 120 Ω and 350 Ω bridge elements
2 and 4 wire current-excitation mode:	
<ul style="list-style-type: none"> - 4, 8 or 12 mA (DC) 	Local and remote sense options
LVDT inductive displacement transducer mode (AC)	
	100 kΩ internal shunt calibration resistor
	Pre-and post-filter overflow monitoring
	Selectable low and high pass digital filters
	LEMO® 7-pin EHG.0B connectors

WSB⁴²

4 Channels of Bridge, ICP®, and Voltage with sampling limits



MD-WSB42

[CONTACT US](#)

The WSB⁴² Module is used with AC and DC bridge measurements including strain gauges configured as full, half or quarter bridges and inductive displacement transducers (LVDT). The Module offers numerous software-selectable features such as constant voltage excitation (AC or DC), bridge completion resistors and shunt calibration. The bridge can be balanced on command or a previous balance value can be recalled.

WHERE USED:

- With any strain gauge in quarter, half and full bridge, load cell and pressure transducer
- Inductive displacement transducer (LVDT)
- With any voltage source up to ±10 V in voltage input mode
- Current-excited sensors in 4-wire mode (full bridge or one external element, DC and AC)
- Current-excited sensors in 2-wire mode (dynamic strain only)
- With any ICP® based sensor commonly used to measure vibration, acceleration, force or pressure

REDUCED SAMPLING RATE

24-bit resolution, 51.2 kSa/s sampling rate per channel, 23 kHz bandwidth

UPGRADE WSB⁴² TO WSB⁴²X

Upgrade maximum sampling rate from 52.1 kSa/s to 204.8 kSa/s

Requires MD-WSB⁴² to be returned to MECALC Technologies for upgrade and calibration.

RELATED SUBMODULE AND SIGNAL CABLES FOR BOTH WSB⁴²X AND WSB⁴²

One of any of the following, per channel:

ITEM NUMBER	DESCRIPTION	
CS-WSB-W	<ul style="list-style-type: none"> - Sensor Cable. Used to connect deflection bridge sensor 7-pin LEMO® to 7 unconnected wires (brown, red, orange, yellow, green, blue, black). - Optional lengths: 2 m (2000) custom length (C) 	
CS-WSB-D	<ul style="list-style-type: none"> - Sensor Cable. Used to connect deflection bridge sensor 7-pin LEMO® to 9-pin D-sub connector. - Length: 2 m 	
CS-A10-J	<ul style="list-style-type: none"> - Voltage/ICP® Sensor Cable. 7-pin LEMO® to single BNC Jack connector. Used to connect direct voltage and ICP® sensors and analog outputs. - Optional lengths: 500 mm 1000 mm 	

ALI⁴²B

2 Channel High Speed Voltage Input Amplifier



MD-ALI42B

The ALI⁴²B Module is a 2 channel high speed Module with sample rates of up to 409.6 kSa/s and a bandwidth of 195 kHz. Both channels operate independently of each other, each with its own mode, gain, coupling, etc. and with all settings done in software. The ALI⁴²B has two BNC connectors and is specifically targeted to high bandwidth analog input applications requiring terminated or unterminated inputs.

WHERE USED:

- With any voltage source up to ±10 V
- Signal sources requiring 50 Ω termination
- Signal sources requiring high input resistance

FEATURES

2 channels	Balanced differential signal input
1 mode of operation: - Voltage input mode	Signal integrity circuit continuously monitors the input and disconnects sensitive circuits during overload conditions
24-bit resolution	DC or AC coupling
409.6 kSa/s sampling rate for 2 channels, 195 kHz bandwidth	Input capacitance: < 100 pF
< 0.3° @ 10 kHz phase accuracy when in similar range	Pre- and post-filter overflow monitoring
± (100 mV, 1 V, 10 V) input ranges for all modes	Selectable low and high pass digital filters
Input resistance: Software switchable between 50 Ω or 2 MΩ	50 Ω BNC connectors

ALI²⁵

The industry's first 5 MSa/s 24-bit Digitizer for PyroShock Applications

2 Channels supporting Bridge, ICP® and Voltage Inputs. Includes buffered analog output channels and advanced options for synchronization and triggering.



MD-ALI25

The ALI²⁵ is a high-bandwidth Module designed for triggered/burst acquisition for Pyro-Shock / Mechanical Shock applications. It also supports continuous sampling modes for high-speed recording. Each channel includes bridge signal conditioning, a 24-bit 5 MSa/s ADC, and a 21 M sample data buffer. Systems can be configured with 2 to over 1000 channels.

Measurement Integrity and Sensor Status prior to an event is verified with continuous: pre-trigger monitoring, summarized signal information, and sensor fault detection.

Built-in Signal Conditioning for bridge-type transducers and voltage signals. Constant voltage or current excitation is programmable for each channel. Each input channel has a buffered low noise output channel for monitoring or acquisition sensor data via a secondary System.

Measurements are triggerable by signal level and persistence, external events, data flow, or software command. This advanced set of triggering options supports multi-system synchronization and ensures event detection.

WHERE USED:

- Acquisition of Pyro-Shock / Mechanical Shock events related to impact / shock, ballistics, and explosives test.
- Bridge and Resistive Sensors that require 4-wire and 6-wire configurations.
- Functions such as shunt resistors across all bridge arms (available through ISM SubModule).
- High Voltage SubModule for external high-voltage signal conditioning used in power measurements.

ANALOG INPUT CHANNELS

2 channels	Memory
24-bit resolution, 5 MSa/s sampling rate per channel	- 21 M Samples per channel, 24-bit
Bandwidth:	Input Ranges
- dc – 2.160 MHz ±0.1dB at 5 MSa/s	- ± (5, 2.5, 1.25) V, ± (600, 300, 150, 75, 40, 20, 10) mV
- dc – 2.375 MHz -3dB at 5 MSa/s	
MODES OF OPERATION:	Connectors
Voltage input mode	- 9-pin LEMO® 0B.309 (one input per channel)
ICP® mode 4 mA to 20 mA with 30V compliance	- Signal+, Signal-, Excitation+, Excitation-, Sense+, Sense-. TEDS (Class 1 & 2), AGND (REF GND), CGND
Bridge Input Mode:	- Separate shield through the housing or pin of the connector (DB15). 9 pin LEMO® to DB15 breakout cable
- 4-wire plus Shield, (Signal+, Signal-, Excitation+, Excitation-), targeting Pyro-Shock applications	
- 6-wire plus Shield, (Signal+, Signal-, Excitation+, Excitation-, Sense+, Sense-)	
- Additional bridge conditioning possible through ISM & PSM (coming soon)	

TRIGGER OPTIONS

- Software Trigger, triggered by a software command
- Data Flow Trigger, programmable data trigger
- External Trigger, triggered by external pulse
- Real Time Trigger, trigger when analog input signal reached and remains above programmable limit
- Backplane Trigger (4 lines)
- Trigger Holdoff, Trigger Output, Latching Mode, System Triggering, Veto
- Synchronous snapshot monitoring of data blocks in parallel to RAM memory
- Synchronous monitoring across all channels while System is running
- 9-pin LEMO® 0B.309 connector

BUFFERED ANALOG OUTPUT CHANNELS

2 channels

Buffered Analog Output Channel for each Analog Input Channel. Provides a conditioned analog output signal for monitoring with a secondary acquisition System.

±1.25 V into 50 Ω for a full-scale input signal

SMB (one connector per output channel)

RELATED SUBMODULES

COMING SOON

ISM / PSM (BRIDGE FUNCTION)

Shunt Calibration

120 Ω, 350 Ω, 1000 Ω and user specified bridge completion options

TEDS

VOLTAGE OUTPUT

ALO^{42S}

4 Channel Voltage Output Source



MD-ALO42S

The ALO^{42S} Module provides four independent output channels for the generation of analog signals. Each channel also incorporates Status Input and Output signals, enabling further communication with external equipment for applications such as test supervision or workflow control.

WHERE USED:



- Excitation signals for shaker / modal testing
- Drive signals for acoustic testing
- Arbitrary analog signals to feed into other circuits requiring ±10 V static or dynamic signals

FEATURES

4 Channels	±10 V @ 30 mA output
24-bit resolution, 102.4 kSa/s sampling rate per channel	10 Ω output impedance
20 kHz 0.1 dB pass band flatness	Automatic safe shut-down upon fault condition
< 0.5° @ 10 kHz phase accuracy	Monitors Device Under Control Input
Each channel includes: <ul style="list-style-type: none"> - Analog Signal Output - Module Status Output - Device Under Control Status Input - 5 V or 12 V DC Voltage Output 	Function generator output types: <ul style="list-style-type: none"> - DC (-10 to 10 V) - Sine (0 to 10 kHz, 20 Vpp, -360° to 360° relative phase) - Square (0 to 10 kHz, 20 Vpp, -360° to 360° relative phase) - Triangle (0 to 10 kHz, 10 Vpp, -360° to 360° relative phase) - White noise (20 Vpp)
Output voltage on Module Status pin: <ul style="list-style-type: none"> - 0 V - 5 V - 12 V 	Signal control: <ul style="list-style-type: none"> - Enable / Disable Channel Output - Module Floating or Grounded Biasing - Amplitude change time (0 to 3600 s; S-curve shaped ramp/fade from previous output to next) - Frequency / Phase change time (0 to 3600 s; S-shaped transition from previous output to new)
Provides Module Status Output	Low noise and distortion performance
DC gain and offset stability	LEMO® 7-pin EHG.0B connectors

RELATED SUBMODULE AND SIGNAL CABLE

One of the following, per channel:

ITEM NUMBER	DESCRIPTION
SM-QuadBNC12	<ul style="list-style-type: none"> - 1 Channel Analog I/O SubModule. 7-pin LEMO® to four BNC connectors. Compatible with RM-SM10 1U RackMount. - Length: 500 mm 
CS-AIO-J	<ul style="list-style-type: none"> - Voltage / ICP® Sensor Cable. 7-pin LEMO® to single BNC Jack connector. Used to connect direct voltage and ICP® sensors and analog outputs. - Optional length: 500 mm 1000 mm 

TIME AND POSITION

GPS^{42S}

Internal GPS Interface



MD-GPS42S

The GPS^{42S} provides accurate GPS time and position data to **QuantusSeries** Systems. Accurate timing information is in the form of a synchronized pulse logical signal. The Module can also be used for synchronization purposes. Here the GPS^{42S} provides the System controller with the synchronized pulse signal to align its internal clock. Systems with this capability are able to synchronize with one another without limitations to position or the total number of Systems.

WHERE USED:

- Synchronizing numerous channels over multiple Systems
- When requiring accurate time and position information

FEATURES

Internal GPS channel
NMEA and UBX Protocols available
4 Hz position updates
Time-stamping for received GPS time and position data to 5 μs resolution
3.3 V antenna voltage
Position accuracy: 2.5 m
1 channel SMA connector for antenna
Receiver type: 56 channels GPS L1C/A, QZSS L1C/A <i>(GALILEO and GLONASS optional)</i>

SYNCHRONIZE WITH GPS

Synchronize multiple Systems through GPS synchronization. Each System must contain a GPS^{42S} Module and be connected to the same network via Wi-Fi. This approach is particularly useful when two test objects are moving in relation to one another, when cabling is difficult due to large distances or under unfavourable environmental conditions. There is no limit to the number of synchronized Systems a GPS cluster can contain.

CAN⁴²S

Interface to 2 Controller Area Network (CAN)



MD-CAN42S

The CAN⁴²S Module provides interfaces to 2 CAN or CAN FD (CAN with Flexible Data-Rate) busses. CAN FD is an extension of the original CAN protocol which allows for higher data bandwidth. Messages received from CAN are time-stamped to synchronize their reception with analog and digital measurements from other Modules in the System. Fully implemented features include Participate Mode, Listen-Only Mode, Self-Reception of sent messages and Loopback Mode. The CAN⁴²S Module provides independent channel filtering.

WHERE USED:

- When monitoring CAN-based messages
- When controlling CAN-based devices

FEATURES

2 CAN / CAN FD Channels	Software-selectable 120 Ω bus termination per channel
2 modes of operation: <ul style="list-style-type: none"> - Participate - activity acknowledges messages on the bus and sends messages - Listen only - passively interprets messages that are sent between other nodes on the bus 	Each CAN message received and accepted by the Module is time-stamped in order to synchronize the received CAN messages with the rest of the measurement data
Supports Arbitration Bit Rates from 50 kbit/s to 1000 kbit/s	Individually configurable identifier list per channel to provide acceptance filtering for all CAN messages received from the CANbus
Supports Data Bit Rates from 500 kbit/s to 8000 kbit/s (single channel only) or 2000 kbit/s (both channels simultaneously)	Individually configurable CAN message transmission
Supports Sample Point configuration for the arbitration phase	Each channel has protection against ESD and other harmful transients
Conforms to ISO 11898-1:2015 (“ISO CAN FD”)	LEMO® 7-pin EHG.0B connectors

RELATED SIGNAL CABLE

One per channel:

ITEM NUMBER	DESCRIPTION
CC-CAN10-D	<ul style="list-style-type: none"> - CANbus cable. 7-pin LEMO® to 9-pin D-sub connector. Compatible with RM-SM10 1U RackMount. - Optional length: 300 mm 2000 mm



LICENSED OPTION

ITEM NUMBER	DESCRIPTION
QS-SYNC-GPS	<ul style="list-style-type: none"> - Enable GPS Synchronization - One license needed per System

ACM⁴²

24 Channel Voltage Input Amplifier



MD-ACM42

[CONTACT US](#)

With one connector for 24 ICP®/Voltage channels, the Acoustic Camera Module provides simplified handling and streamlined cabling. Integrating seamlessly into your array technology, this Module also includes power and communication to the control System.

WHERE USED:

- With any voltage source up to ±10 V in voltage input mode

FEATURES

Supports TEDS IEEE 1451.4 V0.9, V1.0 (Class 1)	Selectable low and high pass digital filters
24-bit resolution, 102.4 kSa/s sampling rate per channel, 44.3 kHz bandwidth	12 V to 28 V supply for external Ethernet camera with software controlled reset switch
2 modes of operation: <ul style="list-style-type: none"> - ICP® mode with 4 mA constant current at 24 V excitation - Voltage input mode with AC or DC coupling 	Signal integrity circuit continuously monitors the input and disconnects sensitive circuits during overload conditions
<0.2° @ 10 kHz phase accuracy when in similar range	2 MΩ differential and 1 MΩ single-ended input resistance
±(10 V, 1 V and 100 mV) input ranges	MDR68 connector to directly connect to the array
Short and open circuit cable monitoring (ICP® mode)	RS232 support for automatic array setup
Low noise 6.5 V supply for sensors	
Pre- and post filter overflow monitoring	



COMING SOON

ATTOQ Modules connect to DECAQ, DECAQL, MICROQ and MICROQ black using the S-Port. The first ATTOQ modules to be released will provide precision GPS and Inertia assisted GPS measurements. Additional modules are being developed for low-speed digital / analog measurements as well as support for new communication protocols.

SGPS:

- Acquire precise time synchronization and position information using a GPS receiver and antenna which can be placed up to 3 m (9.8 ") away from any **QuantusSeries** System.

SNAV - VELOCITY MEASUREMENT:

- Inertia assisted GPS for high resolution velocity measurement with speed update rates of up to 100 Hz.



AQ-SGPS10

ATTOQ GPS Receiver for Time Synchronization and Position

- Synchronize any number of **MICROQs** and **DECAQs** to form a larger System, without cables at any distance
- Synchronize Systems to within 500 ns by aligning the clocks to GPS signals and compensating for clock drift
- Receiver type: 56 channels GPS L1C/A
- Position accuracy: 2.5 m
- Position and time update rates up to 10 Hz
- Connects to S-Port on the **MICROQ**, **MICROQ black** and **DECAQ** via a 3 m cable

AQ-SNAV10

ATTOQ Inertia assisted GPS Receiver

- Synchronize any number of **MICROQs** and **DECAQs** to form a larger System, without cables at any distance
- Synchronize Systems to within 500 ns by aligning the clocks to GPS signals and compensating for clock drift
- Position accuracy: 2.5 m
- Position and time update rate of up to 10 Hz
- Connects to S-Port on the **MICROQ**, **MICROQ black** and **DECAQ** via a 3 m cable
- High-resolution speed measurement using accelerometer, gyroscope and GPS
- Speed update rates up to 100 Hz
- Used in Pass-By testing

AQ-SIMU10 PRELIMINARY

ATTOQ Inertia assisted GPS Receiver with IMU Info

- High-resolution speed measurement using accelerometer, gyroscope and GPS
- Synchronize any number of **MICROQs** and **DECAQs** to form a larger System, without cables at any distance
- Synchronize Systems to within 500 ns by aligning the clocks to GPS signals and compensating for clock drift
- Receiver type: 56 channels GPS L1C/A
- Position accuracy: 2.5 m
- Position and time update rates up to 10 Hz
- Speed update rates up to 100 Hz
- Connects to S-Port on the **MICROQ**, **MICROQ black** and **DECAQ** via a 3 m cable
- Position, time and direction measurement using GPS

CAL-SNAV10-ISO

- Calibration of AQ-SNAV ATTOQ



MINITERMINAL

The MiniTerminal provides a large, bright LED display as a practical solution (even in daylight conditions) to show test information as well as to receive commands from a user. It connects to any one of the System Controller and Power Supply boards found in any Mainframe.

In Automotive measurements, for example, users are able to control all connected Mainframes with a single button. The MiniTerminal also provides the user with valuable test information, such as instructions to a vehicle driver, or acts as a remote control when the operational environment does not allow direct access to the **Quantus** Series System, such as in confined areas.

User input is provided through 7 soft key buttons which can be labelled. These buttons are easy to operate even whilst driving. A piezoelectric buzzer is contained within the unit to alert the user of certain conditions.

The communication cable to the System Controller and Power Supply can be plugged into 1 of 2 sockets found on both the left and right sides of the MiniTerminal. This affords the user the choice of the most comfortable position to insert the cable.

The MiniTerminal is compact and machined from aluminum. A tripod screw thread on its rear lid facilitates easy mounting through third party mounting Systems.

The MiniTerminal is designed to control vehicle measurements in real world environments. The display is readable in daylight and it allows the vehicle operator to easily start and stop measurements with minimal interaction.

[CONTACT US](#)





CUSTOM SOLUTIONS PARTS AND SPARES.

CUSTOM SOLUTIONS

MECALC works closely with our partners to meet the evolving trends in Test and Measurement applications. With one of the largest in-house development teams in the industry, we have the resources to work closely with our partners to meet new challenges.

MECALC works closely with leading manufacturers in Aerospace, Automotive and Defense. Solutions developed through these partnerships drives innovation in the field and guides our product development.

CASE STUDY:

SATELLITE ACOUSTIC TEST

In addition to typical data acquisition tasks, this application required large interconnects to simplify wiring, signal conditioning for 1000' cable lengths, sharing the buffered signals to multiple secondary Systems for real time monitoring and backup acquisition.

MECALC updated its standard I/O modules with new connectors, increased the power and isolation to support long cables, and added buffered outputs to share the conditioned signals. An external signal management System was developed to isolate and share the buffered outputs with multiple secondary Systems.

We look forward to learning about the challenges you face to working on solutions together.

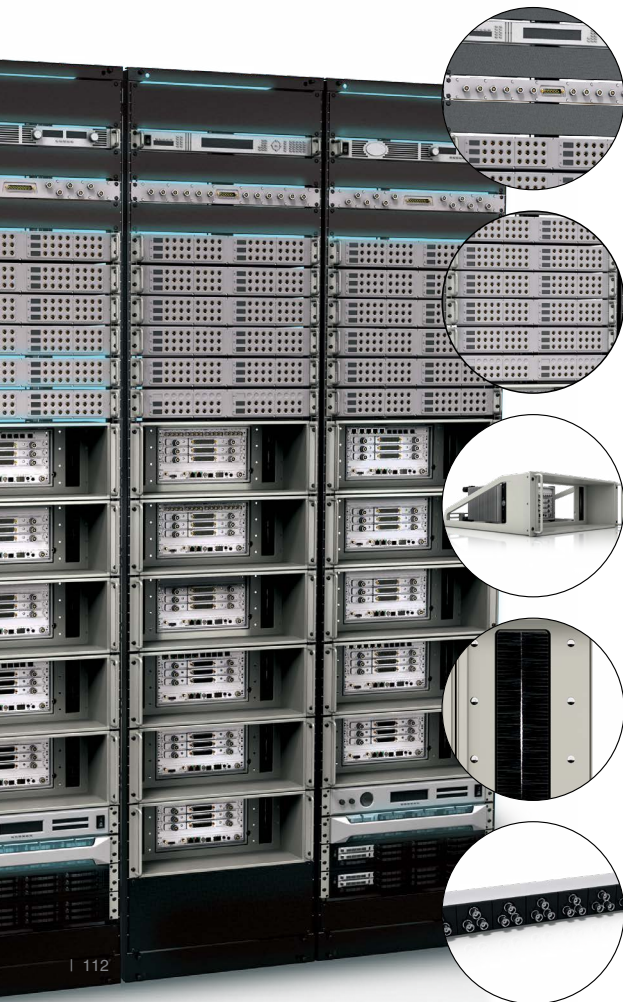

POWER SUPPLY DISTRIBUTION BOARDS

BUFFERED OUTPUTS

DIFFERENT SIZE RACK FOR APPLICABLE SYSTEMS

PRECISION BRUSH TO ROUTE CABLES TO THE BACK

SMRM

SIGNAL CONDITIONING

- Advanced signal conditioning to support low noise applications and specialty sensors with power requirements beyond IEPE.
- SubModules to support ± 20 mA inputs.
- Support for extra sensor cables.

SIGNAL MANAGEMENT

- Signal buffering and distribution to multiple independent output channels to be distributed to secondary Systems.
- The Mobile Mount distributes all measuring channels from the System frontend to BNC connectors on the Mount. This enables easy access to the BNC connectors and simplifies cabling for portable measurements. It can support up to 170 voltage and ICP® channels, as well as additional Tacho input channels.

MOUNTS

- SeatFrame to secure a **QuantusSeries** System in a vehicle's passenger seat. The SeatFrame was enhanced with a Laptop mounting System to support the engineer running the tests in the field.
- DIN Rail mount for installing Systems in a production environment.

CUSTOM CABLES

MECALC will design and manufacture custom cables on request.

SERVICES AND SUPPORT.

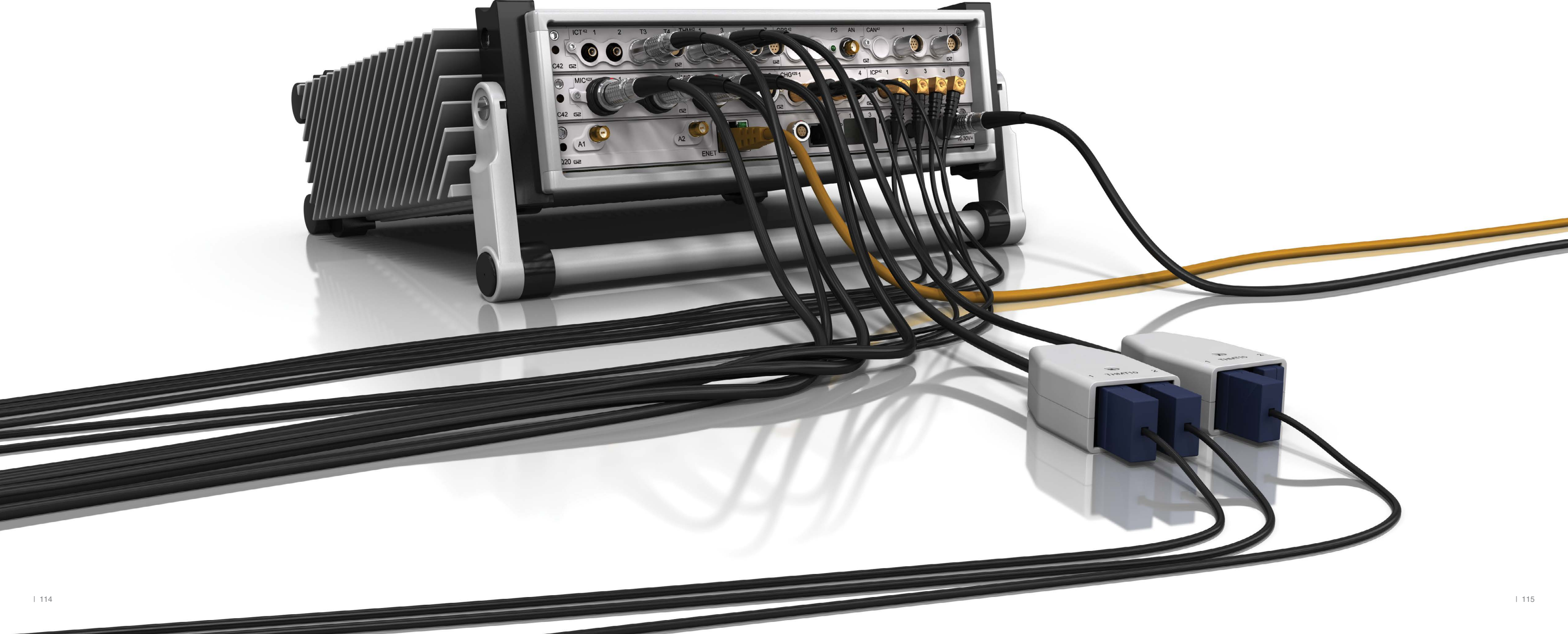

SERVICES AND SUPPORT

MECALC provides a

FULL RANGE OF SUPPORT SERVICES

DESIGNED TO MINIMIZE DOWNTIME AND MAXIMIZE THE LIFE OF YOUR SYSTEM.

All MECALC products are designed, developed, and manufactured in-house. We are invested in every phase of our products' life cycle, including its support and related services.

When you buy a **QuantusSeries** System, you get us. MECALC's support team is readily available to help with any challenge that might arise.

OUR SERVICE AND SUPPORT OBJECTIVES:

UPTIME

To maximize uptime and a long life, we strive to provide quick and proactive support to keep your equipment at its highest operational level.

DIALOGUE

Open two-way communication with our customers helps us respond promptly to all customer requests and questions, as well as keep customers informed of their service status to plan their System health checks effectively.

TECHNICAL EXPERTISE - OUR COMMITMENT TO QUALITY

Our Product Experts are a dedicated team of highly specialized Technicians and Engineers trained to provide the best possible service and support.



TRAINING AND APPLICATION SUPPORT:

Training and product support for **QuantusSeries** and **QServer** is available on-site or online. Software development services are available through our partners. Contact your local MECALC office for more information.

ON-SITE SERVICES:

Most services can be performed at your facility.

On-site Services include:

- MECALC ProCal Calibration Service
- Product Training
- Application Engineering Support

Contact your local MECALC office for more information.

SYSTEM RENTALS:

QuantusSeries Systems are available for rental and rent-to-purchase.



SERVICES AND SUPPORT

All new **QuantusSeries** Systems are delivered with an optional ISO/IEC 17025 accredited calibration and a 2-year Factory Warranty. The main System warranty can be extended up to 10 years by periodically calibrating the System with a **MECALC ProCal** Calibration service.

Calibration and Extended Warranty plans are also available for pre-purchase on new Systems. Additional services offered include technical training, application engineering support, System rentals, and upgrade plans.

Additional warranty, service, and calibration options can be tailored to your requirements.

CALIBRATION OPTIONS:

The ProCal calibration service includes a full factory test of the entire System and exercises all measurement modes on the instrument. As **MECALC** is ISO/IEC 17025 accredited, ProCal is offered as ISO/IEC 17025 accredited calibration or non-accredited calibration.

ProCal is a comprehensive manufacturer's proprietary calibration. This calibration option verifies measurement accuracy plus the correct operation of internal voltage references, grounding, AC coupling, filters, noise performance, excitation voltage, integrity checking, digital channels, all connector pins, Signal Conditioning cards, Wi-Fi, SSD, batteries, handles, buttons, and many more. These tests ensure **QuantusSeries** Systems continue to operate as specified at every stage of their life cycle.

Calibration of Systems that may be periodically reconfigured in the field:

The **QuantusSeries** is a highly modular System and ProCal is designed for Systems that will be reconfigured in the field. Swapping or moving Modules between slots or Systems can then be done with confidence. And, the validity of a System calibration is preserved when a defective Module is replaced with a calibrated Module of the same type.



CUSTOM CALIBRATION SYSTEM:

DCAT is **MECALC's** automated calibration and testing System used for ProCal Calibrations. Each channel is fully exercised and tested using circuits that emulate sensors, such as bridge completion resistors for calibrating a **WSB⁴²X** Module.

A large System may contain tens of thousands of components that can operate in many modes and configurations. **DCAT** was developed to fully exercise and test these complex Systems.

For ISO/IEC 17025 accredited measurements, traceability is established by the calibrated DMM. A statement of compliance to specifications is made for every test as well as for the complete System.

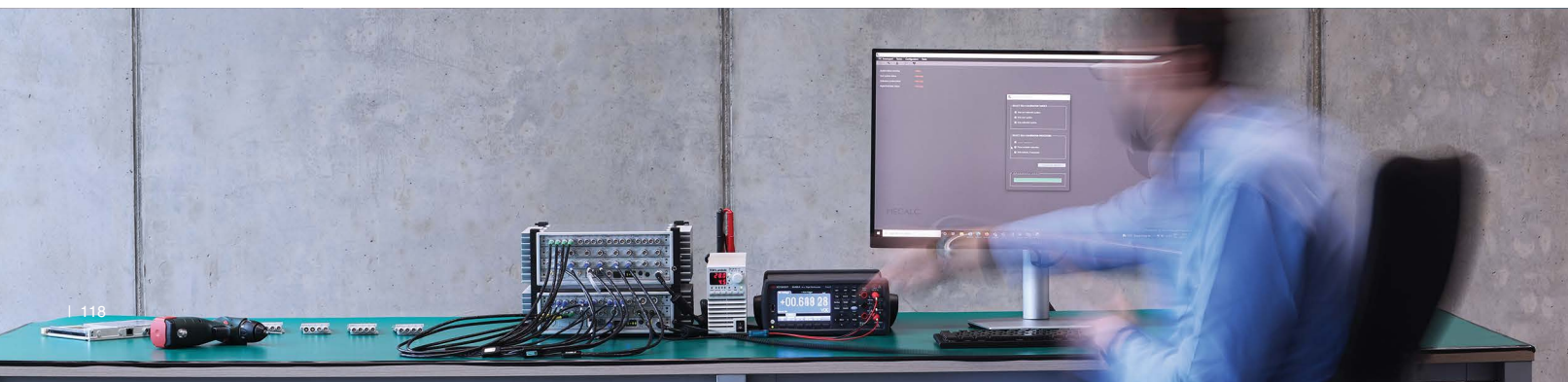

TRAVEL CASES

QuantusSeries Travel Cases are a secure packaging for shipping a System for calibration service.

SERVICES AND SUPPORT

EXTENDED WARRANTY AND REPAIR:

An Extended Warranty is the most cost-effective way to protect your **QuantusSeries** investment.

The **QuantusSeries** Warranty can be extended up to 10 years if the System is regularly serviced with a ProCal Calibration. Extended service plans can be tailored to your requirements on request. Please contact your local **MECALC** office or partner for further info.

External items, like Cables, SubModules, Batteries, and **ATTOQs** are limited to the original two-year factory warranty.

Advantages of an Extended Warranty:

- The known cost of ownership allows for accurate budgeting
- No delays due to budget and approval processes
- Priority support in the event of a defective unit

Maintenance and Repair

- In most installations, our Systems are portable and compact enough to be shipped to a **MECALC** service centre for maintenance and repair.

UPGRADES:

QuantusSeries Systems are designed with the long-term in mind. Our modular concept keeps our Systems updated with the latest technological advances. Components from different generations can coexist in the same System, allowing Systems to be partially upgraded as needed.

MECALC's in-house development team is one of the largest in the industry and regularly adds the latest technological advancements to the **QuantusSeries**. Upgrades to support the latest sensors, improve signal quality, and support new applications are continuously added to the I/O modules. And, new System designs provide faster data processing and data transfer, lower power consumption, higher channel counts, and more.

Contact MECALC for more information about upgrade campaigns and new product releases.

05
year warranty

10
year warranty

15
year warranty

A LASTING INVESTMENT
WITH UPDATES AND NEW FEATURES



MECALC CARES  WE RECYCLE



Module Upgrades

- FROM 4-6 CHANNELS
- ICP® AND VOLTAGE INPUT
- CAN FD CAPABILITY



Infrastructure

- IMPROVED PERFORMANCE
- LOWER POWER CONSUMPTION
- GROWS WITH NEW VERSIONS OF SOFTWARE



Signal Conditioning Upgrade

- MORE POWERFUL SIGNAL PROCESSING
- FASTER DATA RATES
- HIGHER CHANNEL COUNTS
- LOWER POWER CONSUMPTION

WHY CALIBRATE WITH US?

PROPRIETARY PRODUCT KNOWLEDGE

We use our proprietary product knowledge which only MECALC as the manufacturer can provide to test all analog and digital circuits thoroughly. Other calibration laboratories will typically only calibrate voltage or frequency accuracy, while a MECALC calibration also includes a comprehensive System check and verifies aspects such as noise, drift, grounding, AC coupling, TEDS, excitation, balancing, battery performance and many more.

ALL FEATURES FASTER

MECALC calibrates all product features faster than other calibration laboratories. We take roughly 1000 measurements in 30 minutes. Doing this manually would take days. Thus, we ensure that your System is available again for you as quickly as possible with a minimum System downtime. Calibration turn-around time can be additionally minimized by using our on-site calibration offers.

WITH CONFIDENCE

MECALC's ISO/IEC 17025 accreditation offers confidence in the calibration results. MECALC's ISO/IEC 17025 accredited measurements include traceability, uncertainty of measurement, decision rules, guard bands and compliance statements. MECALC is also an ILAC signatory to ensure our calibrations are recognized and accepted worldwide as equivalent to DAkkS or A2LA accredited calibrations.

Regular calibration ensures that the risk of measuring with defective hardware is minimized by detecting defects early. This provides reliable and repeatable measurement results. Regular calibration enables one to establish trends by plotting results on control charts. Should a hardware defect be detected, MECALC product experts can advise on the impact on measurement results and offer repairs without delay. If repairs are required, pre- and post-adjustment calibrations are performed to record any potential changes affecting the repeatability of measurements taken before and after the repair.

EXTEND YOUR WARRANTY

Calibrating with MECALC could also extend your warranty. Please get in touch with your responsible MECALC partner for more details.



SYSTEM
UNDER TEST

TRACEABILITY
ESTABLISHED
THROUGH A CALIBRATED DIGITAL MULTIMETER

DCAT SYSTEM



Your Move

Connect with us

Tell us about your application.

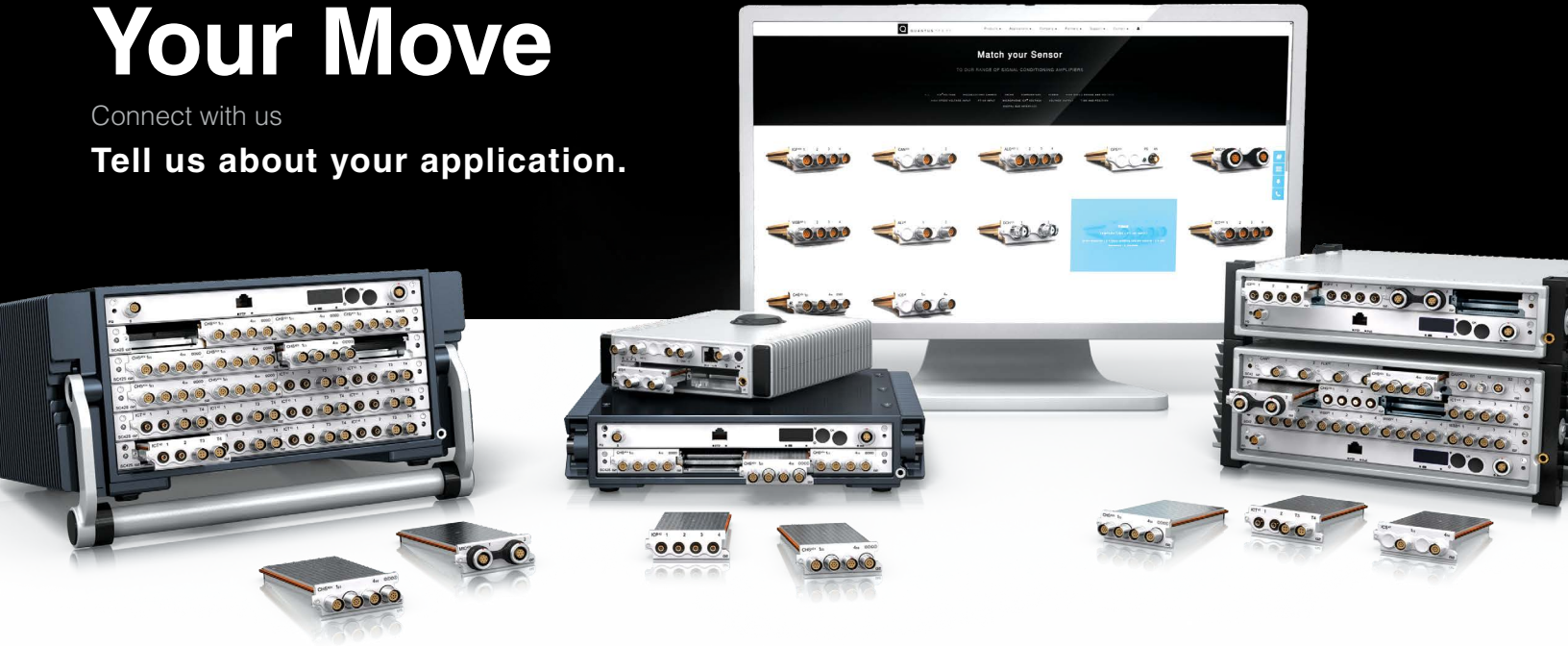

MECALC

technologies

USA | SOUTH AFRICA | EUROPE | ASIA

MECALC.com | hello@QuantusSeries.com

Follow MECALC Technologies

📞 United States: +1-404-800-0825

📞 Germany: +49 (0)30-555-795-760

MECALC IS A HIGHLY SPECIALISED ENGINEERING DESIGN HOUSE WHICH ENJOYS PUSHING INNOVATION AHEAD OF THE GAME.

MECALC researches, designs, develops and manufactures advanced acquisition and control Systems. Since 1984, we've been driven to position ourselves at the forefront of new developments and thinking.

Used to optimise noise, vibration and structural integrity in prototype or quality control testing, our **QuantusSeries** instrumentation is crucial to markets where exceptional development and production quality are essential.

CHARGED TO INNOVATE, we're inspired to create products for those who are as passionate about creating theirs.

a m e c a l c d e s i g n